

MONSOON DRAWING & PARTS LIST
MANUAL MONSOON

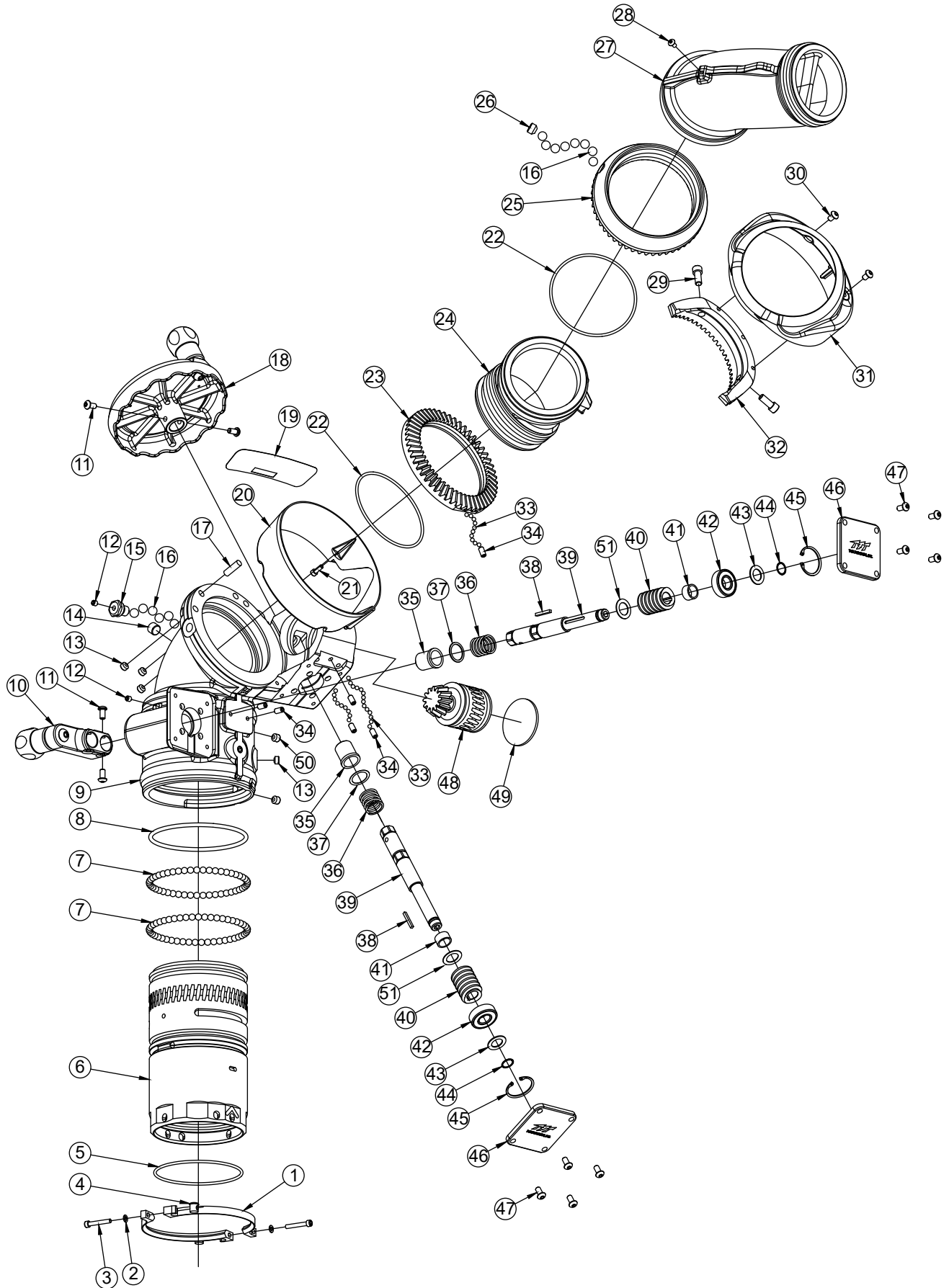

INDEX	DESCRIPTION	QTY	PART #
1	4" MONITOR BASE CLAMP	2	Y4435
	3" MONITOR BASE CLAMP		Y4436
2	WASHER	2	VW360X200-04
3	10-32 X 1 1/4 SOCKET HEAD SCREW	2	VT10-32SH1.2
4	CYLINDER NUT	2	Y4437
5	VO-RING-244	1	VO-244
	VO-RING-236		VO-236
6	BASE CODE-RPF 4"	1	Y4400A
	BASE CODE-RLF 3"		Y4405A
	BASE QUICK CONNECT 4.5"NHF SUBASSY		Y4960
	TILLER BASE QUICK CONNECT 4.5"NHF SUBASSY		Y4961
7	5/16" TORLON BALL (49) PER RACE	98	VB.312TO
8	O-RING-350	1	VO-350
9	LOWER SEGMENT	1	Y4110A
10	CRANK WITH KNOB SUBASSEMBLY	1	A1623
11	1/4-20 X 1/2 BUTTON HEAD SCREW	4	VT25-20BH500
12	1/4-28 X 1/4 SOCKET SET SCREW	2	VT25-28SS250
13	3/8-24 X 3/8 SOCKET SET SCREW	8	VT37-24SS250
14	1/4" NPT PLUG	1	VFSP2M-SS
15	BALL PORT PLUG	1	Y4155
16	7/16" TORLON BALL (32) PER RACE	64	VB437TO
17	DOWEL PIN	1	VP312X1.00
18	ELEVATION HANDWHEEL SUBASSEMBLY	2	Y4941
19	NAME LABEL: MONSOON	1	Y4182
20	LOWER SHROUD	1	Y4130
21	10-24 X 1/2 SOCKET HEAD SCREW	1	VT10-24SH500
22	O-RING-244	2	VO-244
23	LOWER RING GEAR	1	Y4220
24	MIDDLE SEGMENT	1	Y4210A
25	UPPER RING GEAR	1	Y4320
26	1/2-20 X 3/8 SOCKET SET SCREW	1	VT50-20SS375
27	3.5" UPPER SEGMENT	1	Y4310A
	2.5" UPPER SEGMENT		Y4311
28	10-24 X 3/8 BUTTON HEAD SCREW	1	VT10-24BH375
29	5/16-18 X 3/4 SOCKET HEAD SCREW	2	VT31-18SH750
30	1/4-20 X 3/8 BUTTON HEAD SCREW	2	VT25-20BH375
31	UPPER SHROUD	1	Y4240
32	HALF RING GEAR	1	Y4230
33	3/16" TORLON BALL	146	V2120-TORLON
34	1/4-28 X 1/2 SOCKET SET SCREW	6	VT25-28SS500
35	HEADED BUSHING	2	Y4141
36	SHAFT SPRING	2	Y4159
37	WASHER	2	VW1.0X752-01
38	KEY	2	X225
39	DRIVE SHAFT	2	Y4160
40	12 DP WORM	2	X220
41	SPACER	2	Y4150
42	BEARING	2	VM4252
43	WASHER	2	VW97X595-048
44	SMALLEY RING	2	VR4365
45	SNAP RING	2	VR4220
46	COVER PLATE	2	Y4164
47	1/4-28 X 1/2 BUTTON HEAD SCREW	8	VT25-28BH500
48	PINION	1	Y4120
49	PLUG 2-1/4 MOUNTING HOLE	1	Y4162
50	3/8-24 X 5/16 SOCKET SET SCREW	2	VT37-24SS312
51	WASHER	2	VW938X591-03

MONSOON RC

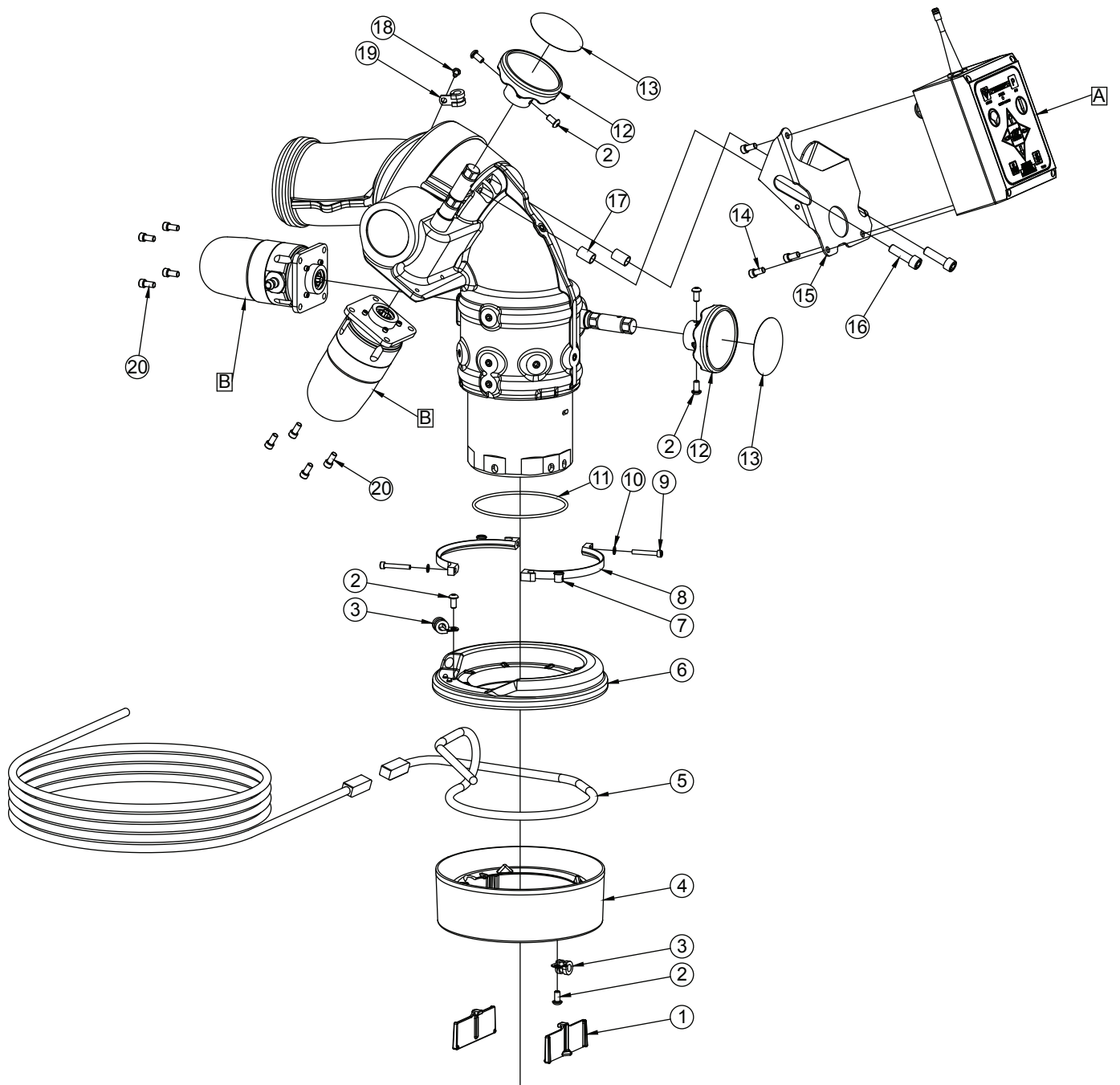

INDEX	DESCRIPTION	QTY	PART #
1	WIRE SKIRT RETAINER	2	Y4661
2	1/4-20 X 1/2 BUTTON HEAD SCREW	6	VT25-20BH500
3	.375 OD LOOP CLAMP STAINLESS	2	Y4655
4	LOWER WIRE SKIRT	1	Y4660
5	CABLE - POWER & COMM.	30'	Y5200
6	UPPER WIRE SKIRT	1	Y4650
7	CYLINDER NUT	2	Y4437
8	4" MONITOR BASE CLAMP	2	Y4435
	3" MONITOR BASE CLAMP		Y4436
9	10-32 X 1 1/4 SOCKET HEAD SCREW	2	VT10-32SH1.2
10	WASHER	2	VW360X200-04
11	VO-RING-244	1	VO-244
	VO-RING-236		VO-236
12	OVERRIDE KNOB	2	Z245
13	OVERRIDE KNOB LABEL	2	Y4176
14	1/4-28 X 1/2 SOCKET HEAD SCREW	3	VT25-28SH500
15	CONTROL BOX BRACKET	1	Y4622
16	3/8-24 X 1-1/4 SOCKET HEAD SCREW	2	VT37-24SH1.2
17	CRANK BUSHING	2	A1513
18	10-24 X 3/8 BUTTON HEAD SCREW	1	VT10-24BH375
19	.500 OD LOOP CLAMP STAINLESS	1	Y4657
20	1/4-28 X 5/8 SOCKET HEAD SCREW	8	VT25-28SH625
A	CONTROL BOX SUBASSEMBLY	1	SEE SECTION 9.4
B	MOTOR ENCLOSURE SUBASSEMBLY	2	SEE SECTION 9.5
* - Length Depends on Configuration.			

MONSOON RC

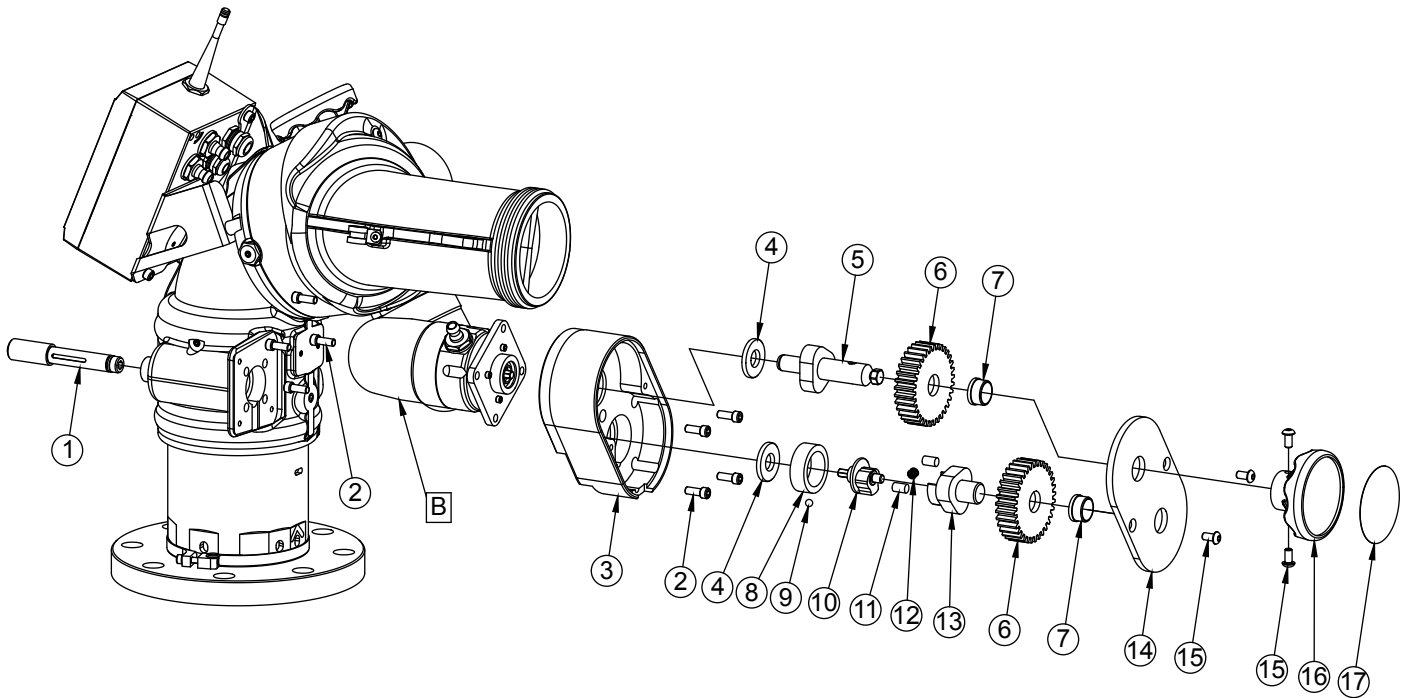

INDEX	DESCRIPTION	QTY	PART #
1	DRIVE SHAFT	1	Y4267
2	1/4-28 X 5/8 SOCKET HEAD SCREW	8	VT25-28SH625
3	GEARBOX	1	Y4260
4	BUSHING	2	XGE637
5	DRIVE SHAFT	1	Y4264
6	GEAR	2	Y4261
7	SHORT HEADED BUSHING	2	XGE634
8	FLOATING RING	1	AY352
9	1/4" SS BALL	1	V2125
10	DRIVEN SHAFT	1	Y4263
11	DOWEL PIN	2	VP312X.50
12	ANTI-BACK-DRIVE SPRING	1	Y4266
13	DRIVING SHAFT	1	Y4265
14	GEARBOX COVER	1	Y4262
15	1/4-20 X 1/2 BUTTON HEAD SCREW	4	VT25-20BH500
16	OVERRIDE KNOB	1	Z245
17	OVERRIDE KNOB LABEL	1	Y4176
B	MOTOR ENCLOSURE SUBASSEMBLY	1	SEE SECTION 9.5

CONTROL BOX SUBASSEMBLY

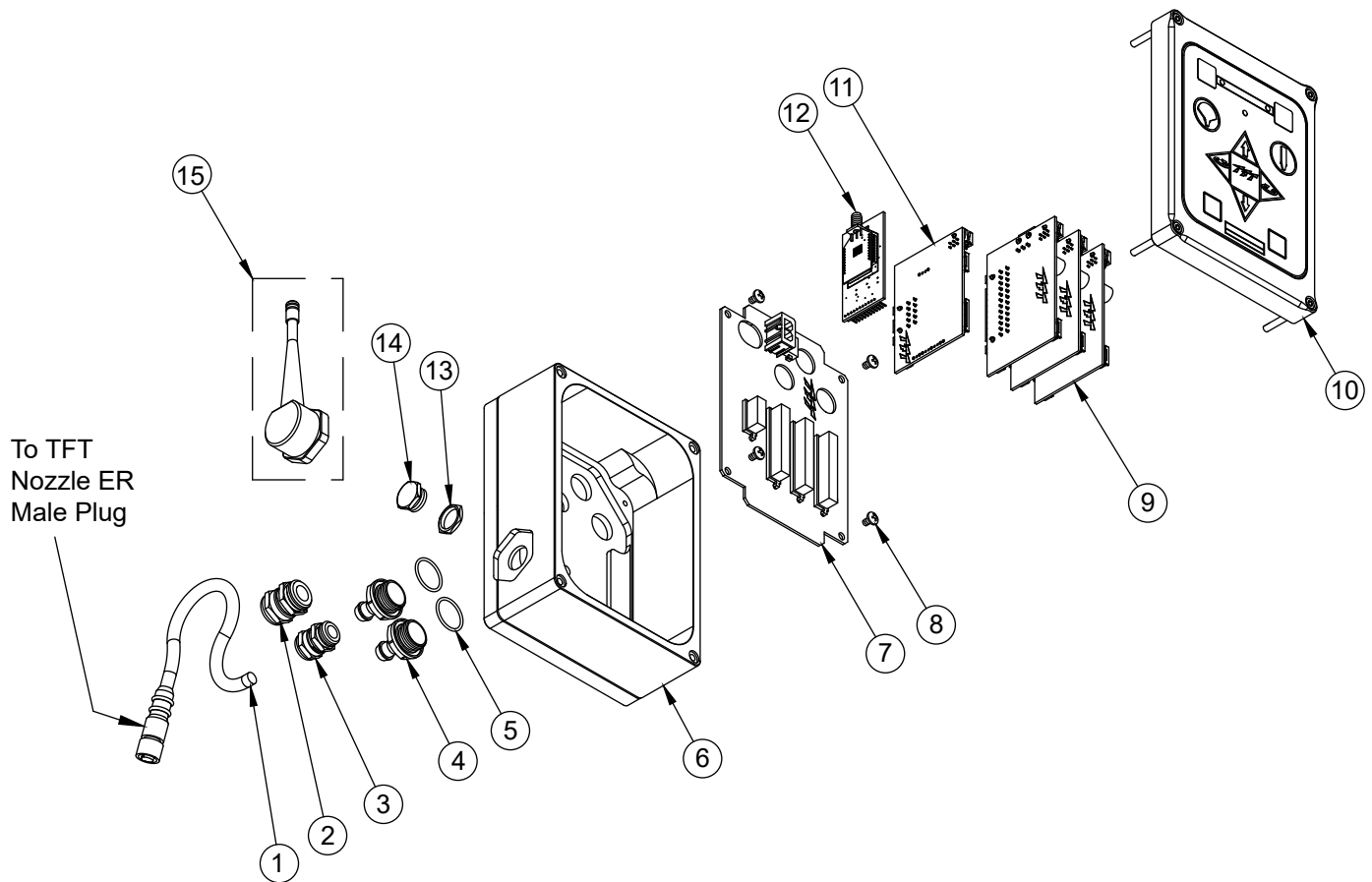

INDEX	DESCRIPTION	QTY	PART #
1	CABLE - 6 POLE FEMALE PLUG	21" or 28" TOTAL LENGTH USED	Y5475
	FOR MONSOON RC NOZZLE CONNECTION	16" or 23" EXPOSED CABLE (NOT INCLUDING PLUG)	
2	PG11 STRAIN RELIEF	1	Y5205A
3	PG9 STRAIN RELIEF	1	Y5245A
4	CONDUIT FITTING	2	Y5213
5	O-RING-018	2	VO-018
6	ENCLOSURE BOX	1	Y5116B
7	MAIN BOARD	1	Y5105
8	M4-0.7 X 6MM PHILLIPS HEAD SCREW	4	VTM4-0.7PH6
9	MOTOR CONTROL BOARD	3	Y5100
10	MONITOR CONTROL BOX SHELL - SUBASSEMBLY	1	Y5801-LID
11	COMMUNICATION BOARD	1	Y5110-B
*12	RADIO + ADAPTER XBEE TO XSTREAM 900 MHZ RADIO	1	Y5891
	RADIO + ADAPTER XBEE TO XSTREAM 2.4 GHZ RADIO		Y5893
13	PG9 LOCKNUT	1	Y5246
14	PG9 HEX PLUG	1	Y5248
*15	900/920 MHZ ANTENNA W/FITTING & CONN. SUBASSY.	1	Y5897
	2.4 GHZ ANTENNA ADAPTER W/CONN. SUBASSY.		Y5898
* - OPTIONAL			

MOTOR ENCLOSURE SUBASSEMBLY

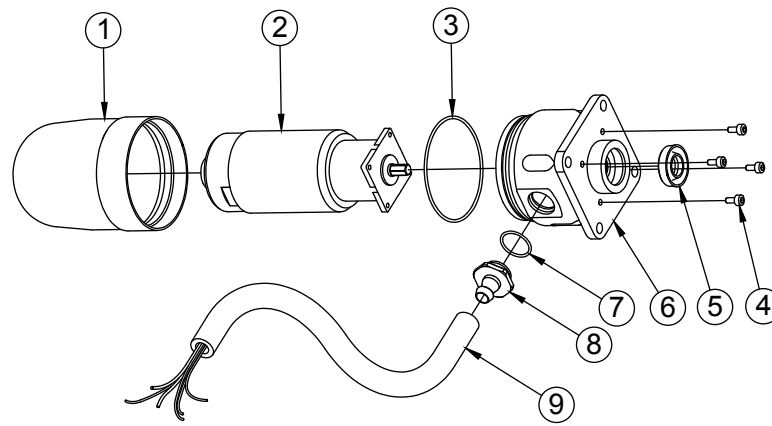

INDEX	DESCRIPTION	QTY	PART #
1	ENCLOSURE	1	Y4616
2	GEAR MOTOR W/CRIMPED TERMINALS	1	Y4611
3	O-RING-038	1	VO-038
4	6-32 X 5/16 LONG SHCS WITH HEAD SEAL	4	VT06S32SH312
5	CUP SEAL	1	Y4620
6	MOTOR SOCKET	1	Y4615
7	O-RING-018	1	VO-018
8	CONDUIT FITTING	1	Y5213
9	HOSE - 3/8" ID PUSH-LOK	1	Y5250