



TASK FORCE TIPS

Technical Bulletin

March 16, 1994

FORCE REQUIRED TO MOVE PORTABLE MONITORS AND WEAR ON LEG SPIKES

Purpose: To determine the force required to cause a monitor on a portable monitor base to slide on common surfaces such as concrete, asphalt, gravel, and turf, at low nozzle elevation angles. In addition, the spikes, which make contact with the ground on the base, were dragged on concrete and asphalt and the wear and resistance to sliding was measured.

Sliding Test Procedure: Force was applied to the monitor on a portable base by a pneumatic cylinder with a regulated air supply. Air pressure was recorded when the monitor slid, and multiplied by the area of the cylinder to determine the force applied. The Force was applied to the monitor at an elevation angle of thirty-five degrees with respect to the base and with base rotation angles of zero, forty-five and ninety degrees to the applied force, see Figure 1

Drag Test Procedure: New base spikes were dragged on asphalt and concrete with a fixed 42 lbs. weight directly above the spike. Spike wear and the force to cause sliding were measured at regular intervals, see Figure 2.

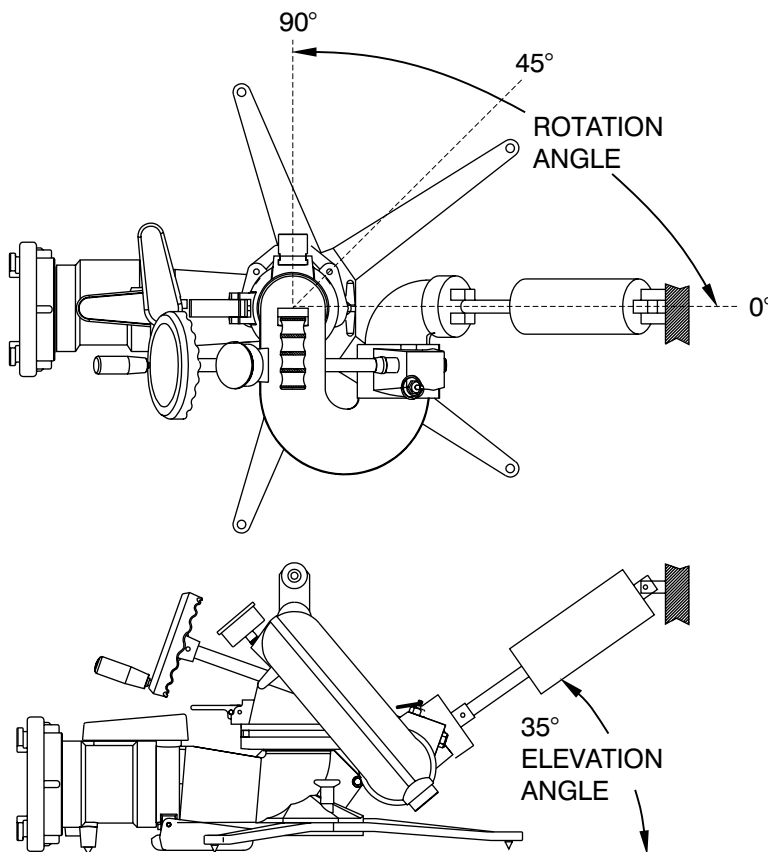

FIGURE 1
SLIDING TEST

Equipment:

- Akron Apollo® monitor and portable base.
- Elkhart Stinger® monitor and portable base.
- TFT Crossfire® monitor and portable base.
- Pneumatic Cylinder 3" dia. piston.
- 0-150 psi air pressure regulator.
- Air compressor and air line.
- 42 lbs. weight.
- Drag test sled.

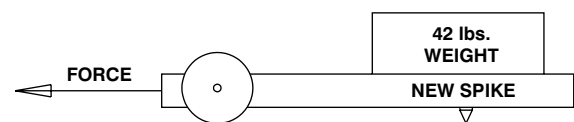

FIGURE 2
DRAG TEST

TASK FORCE TIPS, INC.

2800 East Evans Avenue, Valparaiso, IN 46383-6940
800-348-2686 219-462-6161 FAX 219-464-7155

Sliding Test Discussion: The force required to move the monitor was a function of the hardness and smoothness of the surface and the sharpness of the spikes. The Monitors were tested side by side at the same site to minimize differences in the test surface. Since the composition and smoothness of the test surfaces were not the same at every point, a minimum of three trials were done in each configuration and averaged. (figure 3) The tests on smooth and medium concrete were done with the monitor resting on the concrete, and repeated with each leg spike being "set" with one hit with an Akron aluminum spike hammer directly over the spike. (figure 4) Photographs of the hard test surfaces can be found in Appendix 1. Grooves caused by the leg spikes can be seen in several of the photographs.

Surface	Stinger®	Apollo®	Crossfire®	Stinger® (set)	Apollo® (set)	Crossfire® (set)
Smooth Concrete 0°	37.71	37.71	51.85	96.62	212.10	761.79
Smooth Concrete 45°	40.06	35.35	63.63	80.13	240.38	278.09
Smooth Concrete 90°	51.85	35.35	32.99	120.19	245.09	299.30
Medium Concrete 0°	87.20	167.32	141.40	108.41	259.23	669.29
Medium Concrete 45°	70.70	136.69	155.54	80.13	341.72	370.00
Medium Concrete 90°	61.27	176.75	153.18	89.55	381.78	254.52
Rough Concrete 0°	106.05	414.77	603.31	Force (lbf) Required To Cause Monitor Sliding At 35° Elevation Angle.		
Rough Concrete 45°	96.62	181.46	735.28			
Rough Concrete 90°	113.12	169.68	492.54			
Smooth Asphalt 0°	77.77	216.81	707.00			
Smooth Asphalt 45°	61.27	346.43	641.01			
Smooth Asphalt 90°	77.77	443.05	636.30			
Medium Asphalt 0°	129.62	838.97	860.18			
Medium Asphalt 45°	169.68	850.76	950.92			
Medium Asphalt 90°	113.12	777.70	876.68			
Crushed Limestone 0°	75.41	164.97	173.22			
Crushed Limestone 45°	115.48	194.43	247.45			
Crushed Limestone 90°	98.98	268.66	153.18			
Turf 0°	273.37	395.92	292.23			
Turf 45°	311.08	377.07	285.16			
Turf 90°	200.32	365.28	311.08			

SPIKE TIP WEAR ON CONCRETE and ASPHALT

	Apollo®	Stinger®	Crossfire®	Apollo®	Stinger®	Crossfire®	Apollo®	Stinger®	Crossfire®
	tip wear	tip wear	tip wear	tip dia.	tip dia.	tip dia.	Force	Force	Force
Med Asphalt									
0 feet	0	0	0				90-100	45-50	95-100
5 feet	0.008	0.005	0				85-95	40-45	95-100
10 feet	0.016	0.011	0.002				85-95	40-45	95-100
15 feet	0.02	0.014	0.002				80-90	40-45	95-100
20 feet	0.025	0.015	0.002				80-90	40-45	95-100
25 feet	0.032	0.017	0.002				80-90	40-45	95-100
30 feet	0.044	0.02	0.002				75-80	40-45	95-100
Med Conc.									
0 feet	0	0	0	0.035	0.000	0.03	45-50	45-50	45-50
5 feet	0.06	0.035	0	0.059	0.095	0.03	40-45	40-45	45-50
10 feet	0.085	0.049	0	0.106	0.135	0.03	35-40	40-45	45-50
15 feet	0.1	0.059	0	0.118	0.165	0.03	30-35	40-45	45-50
20 feet	0.11	0.065	0	0.126	0.180	0.03	30-35	40-45	45-50
25 feet	0.123	0.07	0.012	0.137	0.195	0.04	30-35	40-45	45-50
30 feet	0.132	0.079	0.025	0.145	0.220	0.05	35-40	40-45	45-50

SLIDING TEST RESULTS

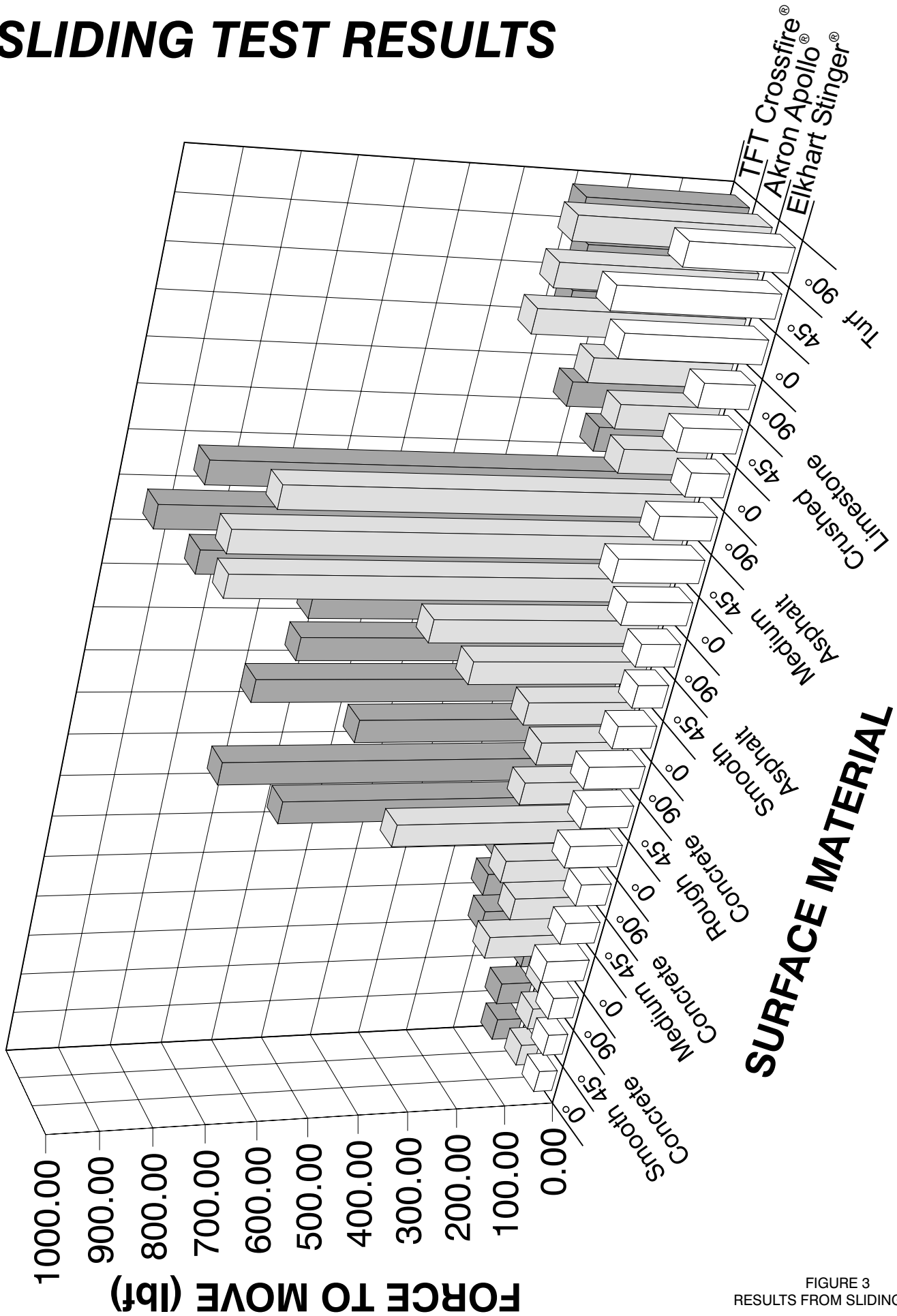

FIGURE 3
RESULTS FROM SLIDING TEST

EFFECT OF "SETTING" LEGS ON CONCRETE

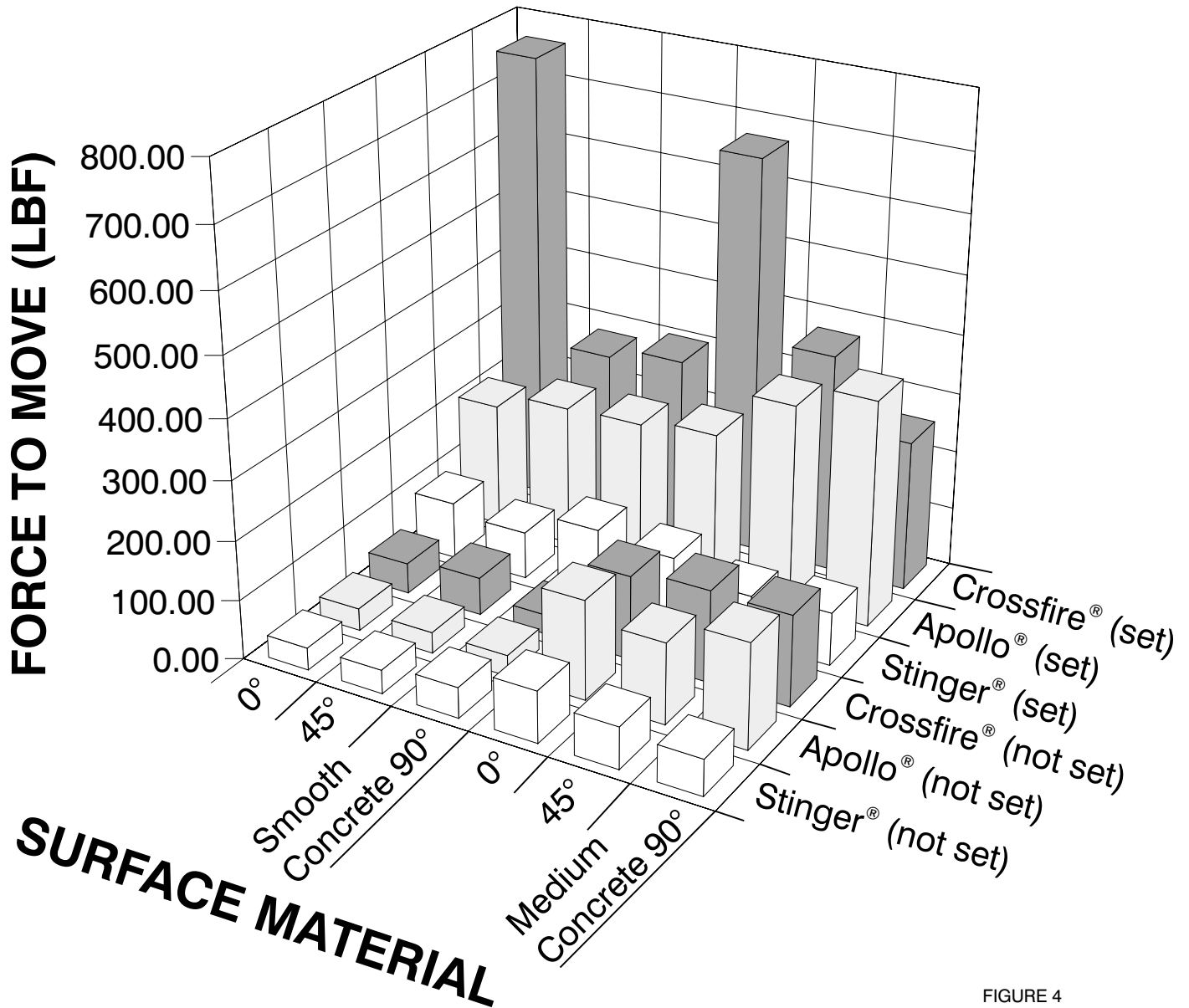
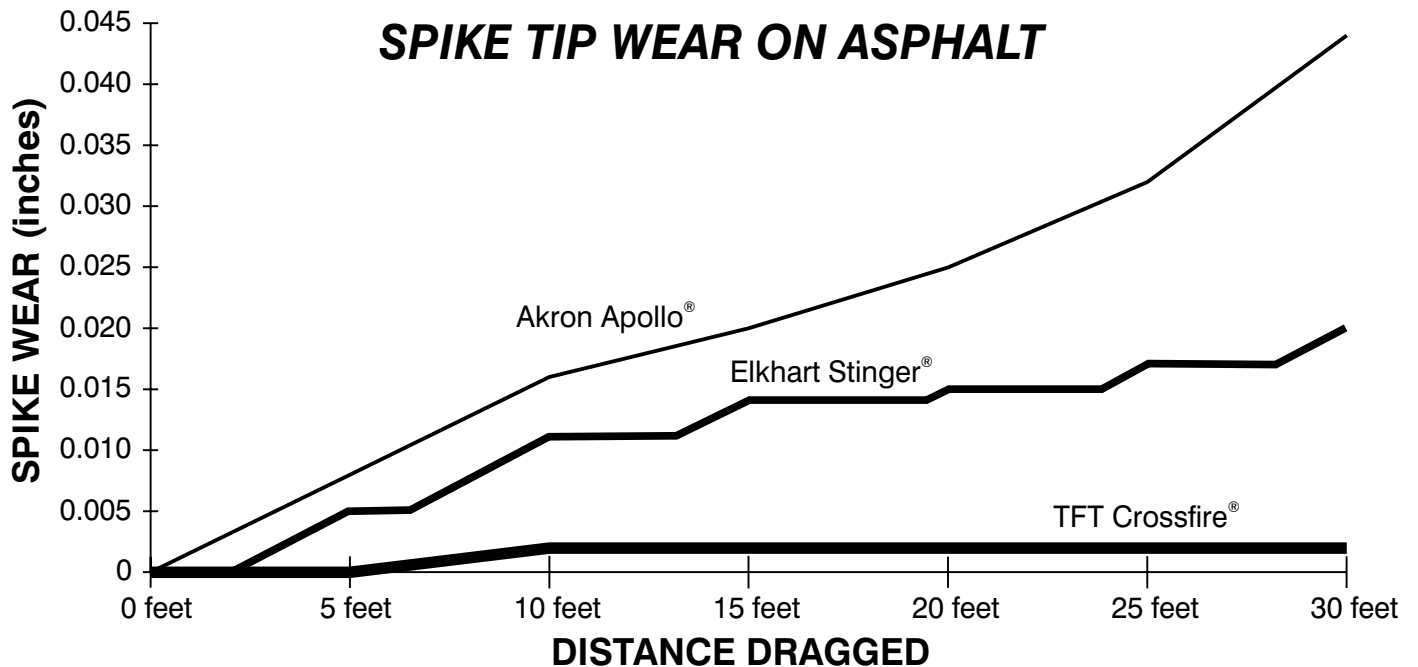
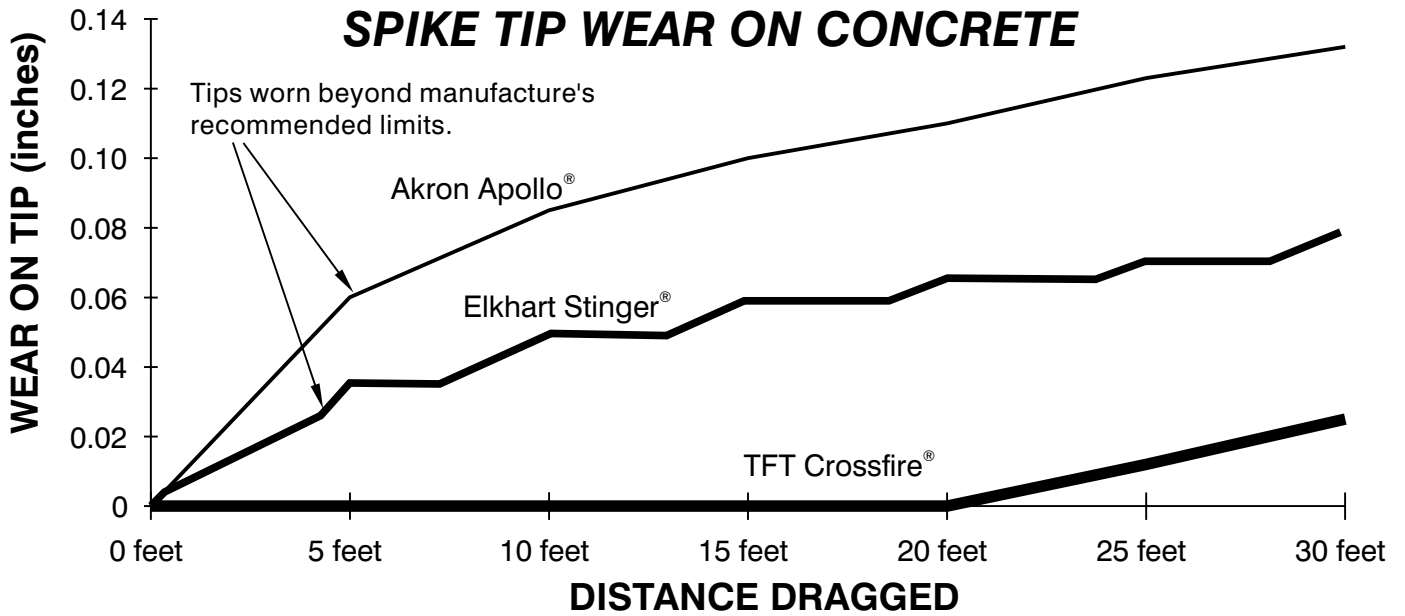

FIGURE 4
RESULTS FROM SLIDING TEST

Sliding Test Conclusion: The Task Force Tips Crossfire Monitor resisted sliding as well or better than the Akron Apollo and the Elkhart Stinger on all surfaces except turf, where the Akron's spikes were able to penetrate deeper into the soil before the leg touched the surface of the ground. The Crossfire monitor carbide spikes showed no visible wear at the conclusion of the slide testing, the Akron spikes required replacement at the conclusion of the testing, based on the Akron Apollo instruction manual. On hard surfaces, the holding power of the Akron and Task Force Tips portable bases were improved greatly by "setting" the spikes with a hammer, however, experience has shown that the monitor rarely remains where it was set once the hose line has been charged. "Setting" the spikes on the Elkhart did not make a noticeable difference. If the leg spikes move out of the shallow depression in which they are "set," holding power is greatly reduced, by as much as fifteen times. (see figure 4)

When a monitor is flowing water at 1000 gpm the reaction force is in excess of 500 lbf. At nozzle elevation angles below 35 degrees, with respect to the base, more than 80% of this force is parallel to the surface the monitor base is sitting on. Hard smooth surfaces, such as smooth and medium concrete, and loose aggregates, such as crushed limestone, are poor surfaces to resist sliding. For this reason the spikes must not be relied on to provide the sole means to resist sliding. **Task Force Tips firmly believes that monitors on portable bases should always be secured to an object, capable of withstanding the entire reaction force of the nozzle, with the strap or chain provided by the manufacturer.**

Discussion, Drag Test: The spikes were dragged with the weight over the spikes to determine wear. On concrete change in length and tip diameter were measured. On asphalt only the change in length was measured because a great deal of the wear was on the side of the spike as the spike plowed through the asphalt, leaving the tip rounded and uneven. Photographs showing a new and the worn spikes can be found in Appendix 2. A scale, marked in 32nds of an inch can be seen in the photographs.



Drag Test Conclusion: The carbide tipped spikes on the Task Force Tips Crossfire resisted wear, on both asphalt and concrete, far better than the Akron or Elkhart tool steel spikes. After each was dragged under load for thirty feet, the Crossfire's spikes showed negligible wear, while the Apollo's and Elkhart's spikes were badly worn.

SURFACE ROUGHNESS

(6" pocket scale shown for size reference)

SMOOTH CONCRETE

SMOOTH ASPHALT

MEDIUM CONCRETE

MEDIUM ASPHALT

ROUGH CONCRETE

CRUSHED LIMESTONE

DRAG TEST on ASPHALT and CONCRETE

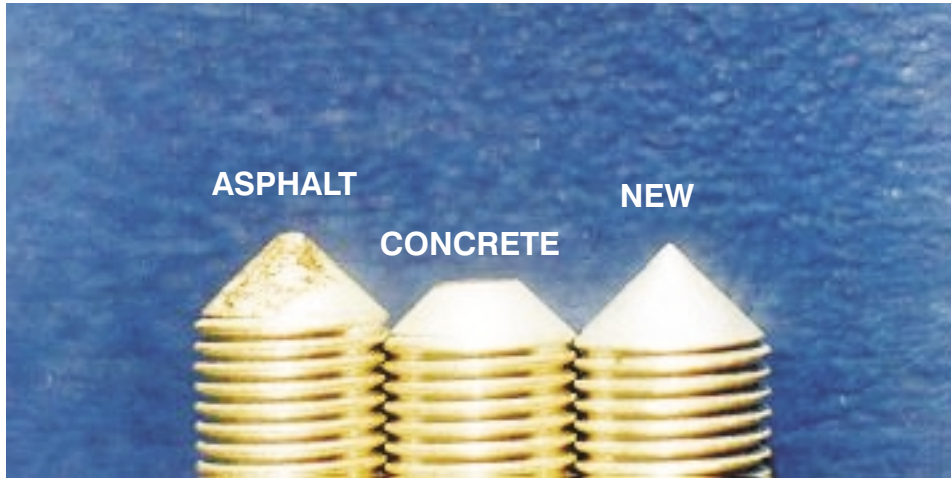

Results of ELKHART STINGER® being dragged 30 feet.

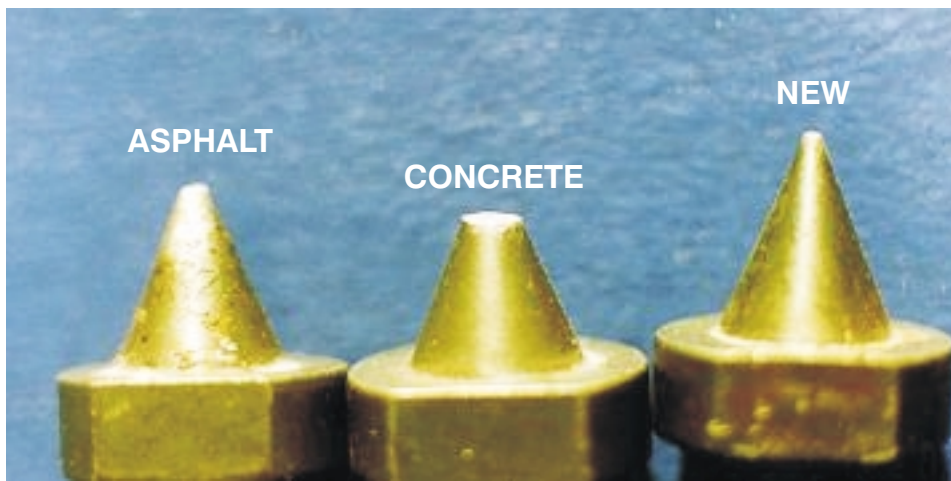

Results of AKRON APOLLO® being dragged 30 feet.

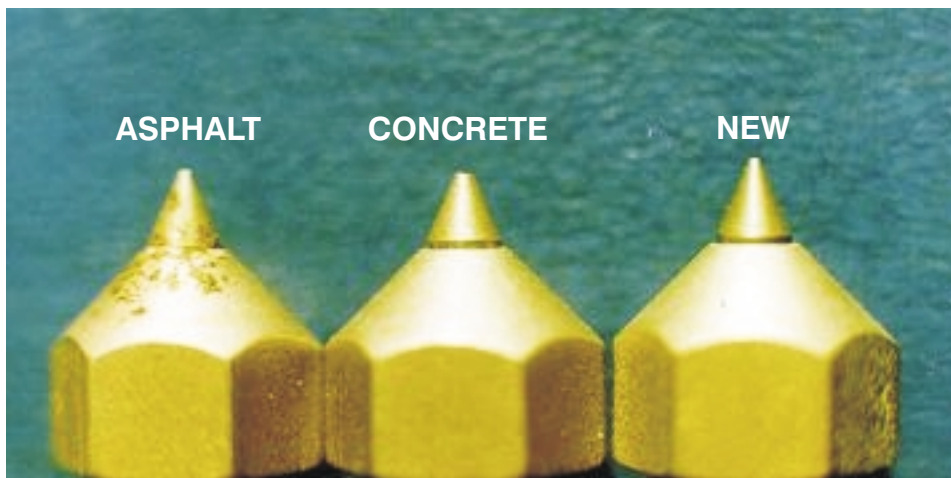

Results of TASK FORCE TIPS CROSSFIRE® being dragged 30 feet.

RESULTS OF CONCRETE DRAG TEST

Dragged 30 ft
on Concrete

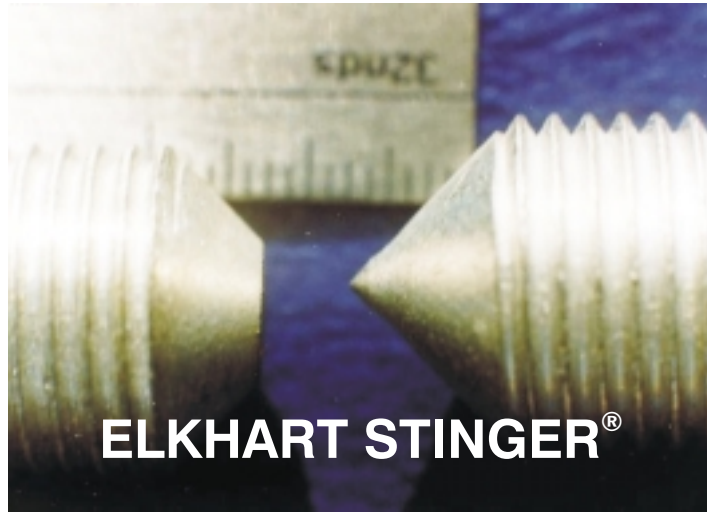

New Tip

Dragged 30 ft
on Concrete



New Tip

Dragged 30 ft
on Concrete



New Tip