



TRANSFORMER

NOZZLE SYSTEM

INSTRUCTIONS FOR OPERATION, AND MAINTENANCE

WARNING

Understand manual before use. Operation of this device without understanding the manual and receiving proper training is a misuse of this equipment. Obtain safety information at tft.com/serial-number.

This equipment is intended for use by trained and qualified emergency services personnel for firefighting. All personnel using this equipment shall have completed a course of education approved by the Authority Having Jurisdiction (AHJ).

This instruction manual is intended to familiarize firefighters and maintenance personnel with the operation, servicing, and safety procedures associated with this product. This manual should be kept available to all operating and maintenance personnel.

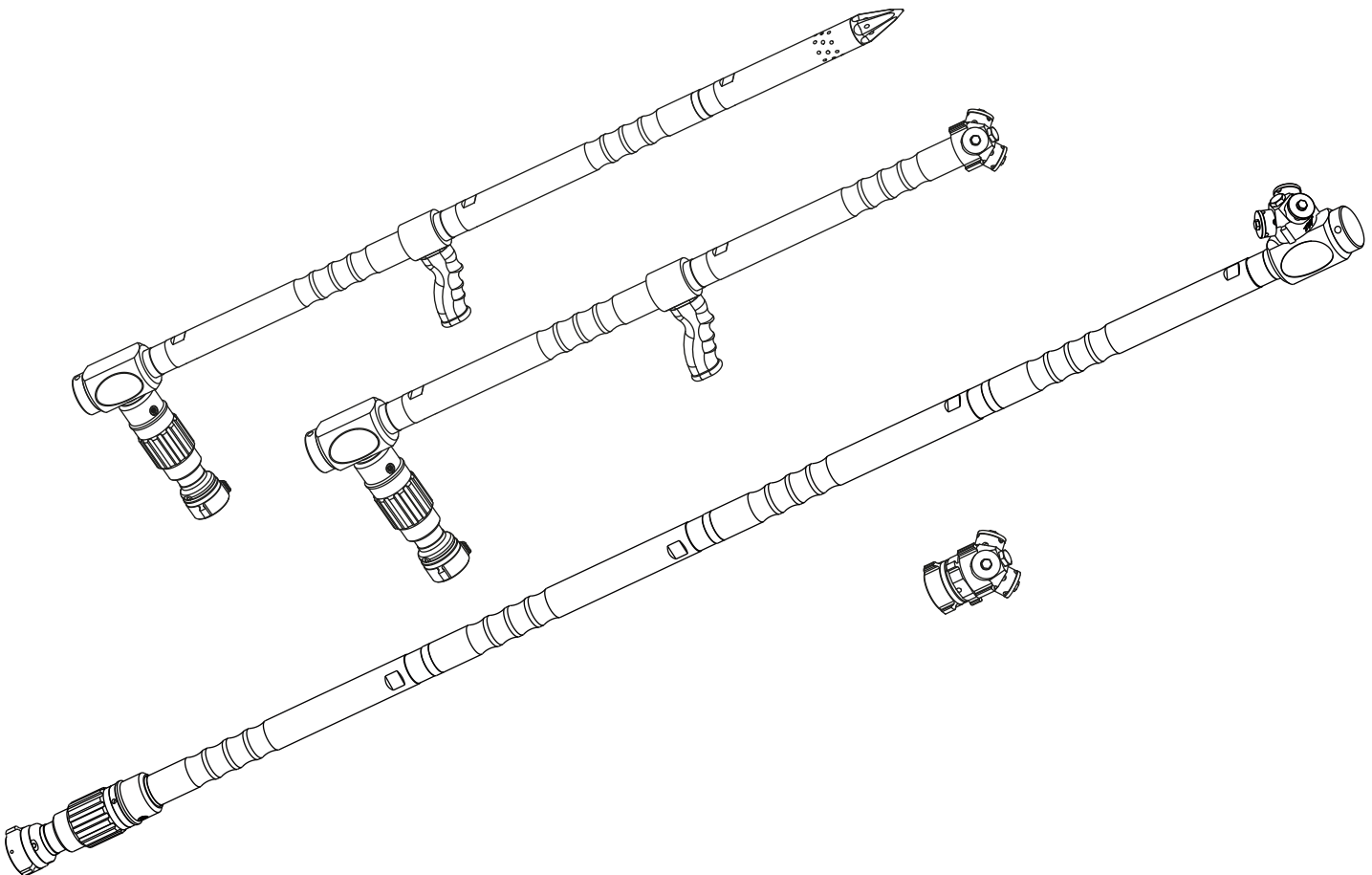

TASK FORCE TIPS LLC
MADE IN USA · tft.com

3701 Innovation Way, Valparaiso, IN 46383-9327 USA
800-348-2686 · 219-462-6161 · Fax 219-464-7155

TABLE OF CONTENTS

- 1.0 MEANING OF SAFETY SIGNAL WORDS
- 2.0 SAFETY
- 3.0 GENERAL INFORMATION
 - 3.1 VARIOUS CONFIGURATIONS AND TERMS
 - 3.2 SPECIFICATIONS
 - 3.3 USE WITH SALT WATER
 - 3.4 NOZZLE COUPLINGS
- 4.0 NOZZLE CONTROLS
 - 4.1 FLOW CONTROL
 - 4.2 VALVE OPERATION
- 5.0 USING THE TRANSFORMER
 - 5.1 ASSEMBLY
 - 5.1.1 STRIKING HEAD
 - 5.1.2 PIERCING POINT
 - 5.1.3 DISTRIBUTOR NOZZLE
- 6.0 USE WITH FOAM
- 7.0 WARRANTY
- 8.0 MAINTENANCE
 - 8.1 FIELD LUBRICATION
 - 8.2 SERVICE TESTING
 - 8.3 REPAIR
- 9.0 EXPLODED VIEWS AND PARTS LISTS
- 10.0 OPERATION AND INSPECTION CHECKLIST

DANGER

PERSONAL RESPONSIBILITY CODE

The member companies of FEMSA that provide emergency response equipment and services want responders to know and understand the following:

1. Firefighting and Emergency Response are inherently dangerous activities requiring proper training in their hazards and the use of extreme caution at all times.
2. **IT IS YOUR RESPONSIBILITY** to read and understand any user's instructions, including purpose and limitations, provided with any piece of equipment you may be called on to use.
3. **IT IS YOUR RESPONSIBILITY** to know that you have been properly trained in Firefighting and/or Emergency Response and in the use, precautions, and care of any equipment you may be called upon to use.
4. **IT IS YOUR RESPONSIBILITY** to be in proper physical condition and to maintain the personal skill level required to operate any equipment you may be called upon to use.
5. **IT IS YOUR RESPONSIBILITY** to know that your equipment is in operable condition and has been maintained in accordance with the manufacturer's instructions.
6. Failure to follow these guidelines may result in death, burns or other severe injury.

Fire and Emergency Manufacturers and Service Association, Inc.
PO Box 147, Lynnfield, MA 01940 • www.FEMSA.org



© 2022 FEMSA. All Rights Reserved.



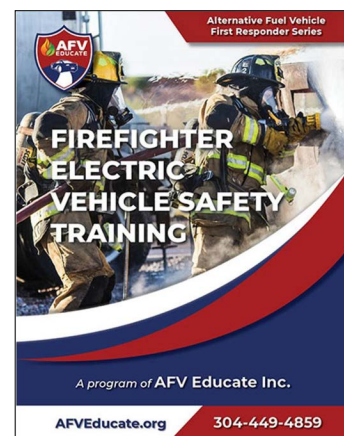
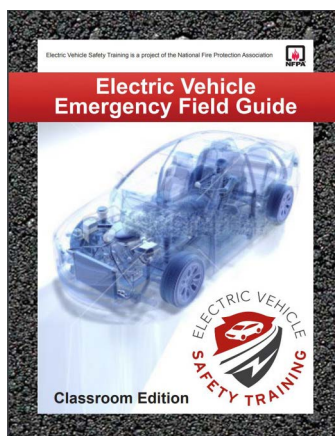
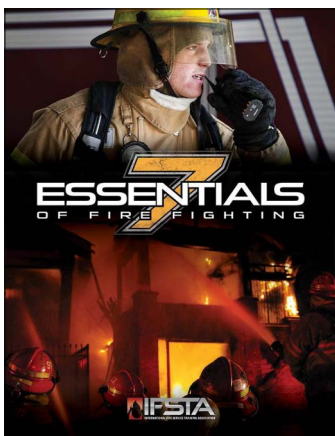

This Safety Manual is not intended as a substitute for proper training in the use of fire fighting equipment as taught from credible sources such as the National Fire Protection Association (NFPA), The International Fire Service Training Association (IFSTA), or sources approved by the Authority Having Jurisdiction (AHJ).

Examples of recent publications:











1.0 MEANING OF SAFETY SIGNAL WORDS

A safety related message is identified by a safety alert symbol and a signal word to indicate the level of risk involved with a particular hazard. Per ANSI Z535.6, the definitions of the four signal words are as follows:

	DANGER indicates a hazardous situation which, if not avoided, will result in death or serious injury.
	WARNING indicates a hazardous situation which, if not avoided, could result in death or serious injury.
	CAUTION indicates a potentially hazardous situation which, if not avoided, could result in minor or moderate injury.
	NOTICE is used to address practices not related to physical injury.

2.0 SAFETY

	An inadequate supply of pressure and/or flow will cause an ineffective stream and can result in injury or death. Choose operating conditions to deliver adequate fire suppression. See flow graphs.
	This equipment is intended for use by trained personnel for firefighting. Use of this equipment for other purposes may involve hazards not addressed by this manual. Seek appropriate guidance and training to reduce risk of injury.
	Equipment may be damaged if frozen while containing significant amounts of water. Such damage may be difficult to detect visually. Subsequent pressurization can lead to injury or death. Any time the equipment is subject to possible damage due to freezing, it must be tested and approved for use by qualified personnel before being considered safe for use.
	Failure to restrain nozzle reaction can cause injury from loss of footing and/or stream protection. Opening and closing other nozzles, hose line kinks, changes in pump settings, nozzle pattern, or flushing will cause changes in nozzle reaction. Nozzle operator must always be prepared in the event of these changes.
	If nozzle gets out of control while flowing, violent whipping motion will occur. Serious injury or death could result. Retreat from the nozzle immediately. Do not attempt to regain control of nozzle while flowing.
	Application of water or foam solutions on energized electrical equipment could cause electrocution. Serious injury or death could result. Assume circuits are energized until confirmed to be de-energized. Do not apply water or foam to energized electrical equipment.
	The stream exiting a nozzle is powerful and capable of causing injury and property damage. Make sure the nozzle is securely attached and pointing in a safe direction before water is turned on. Do not direct water stream to cause injury or damage to persons or property.
	To prevent mechanical damage, do not drop or throw equipment.

3.0 GENERAL INFORMATION

The Task Force Tips Transformer Nozzle System allows delivery of water or foam solutions to locations inaccessible to firefighters using standard nozzles. Transformer Nozzles consist primarily of hard coated extruded aluminum and features a hardened stainless steel point. A series of jets in and near the tip apply a wide reaching spherical flow. A swivel coupling with 1.5" NH (38mm) female hose thread is standard (National Hose Threads per NFPA 1960). Nominal rated flow is 150 gpm at 100 psi (570 L/min at 7 bar).

3.1 VARIOUS CONFIGURATIONS AND TERMS

Possible Configurations Include, but are not limited to:

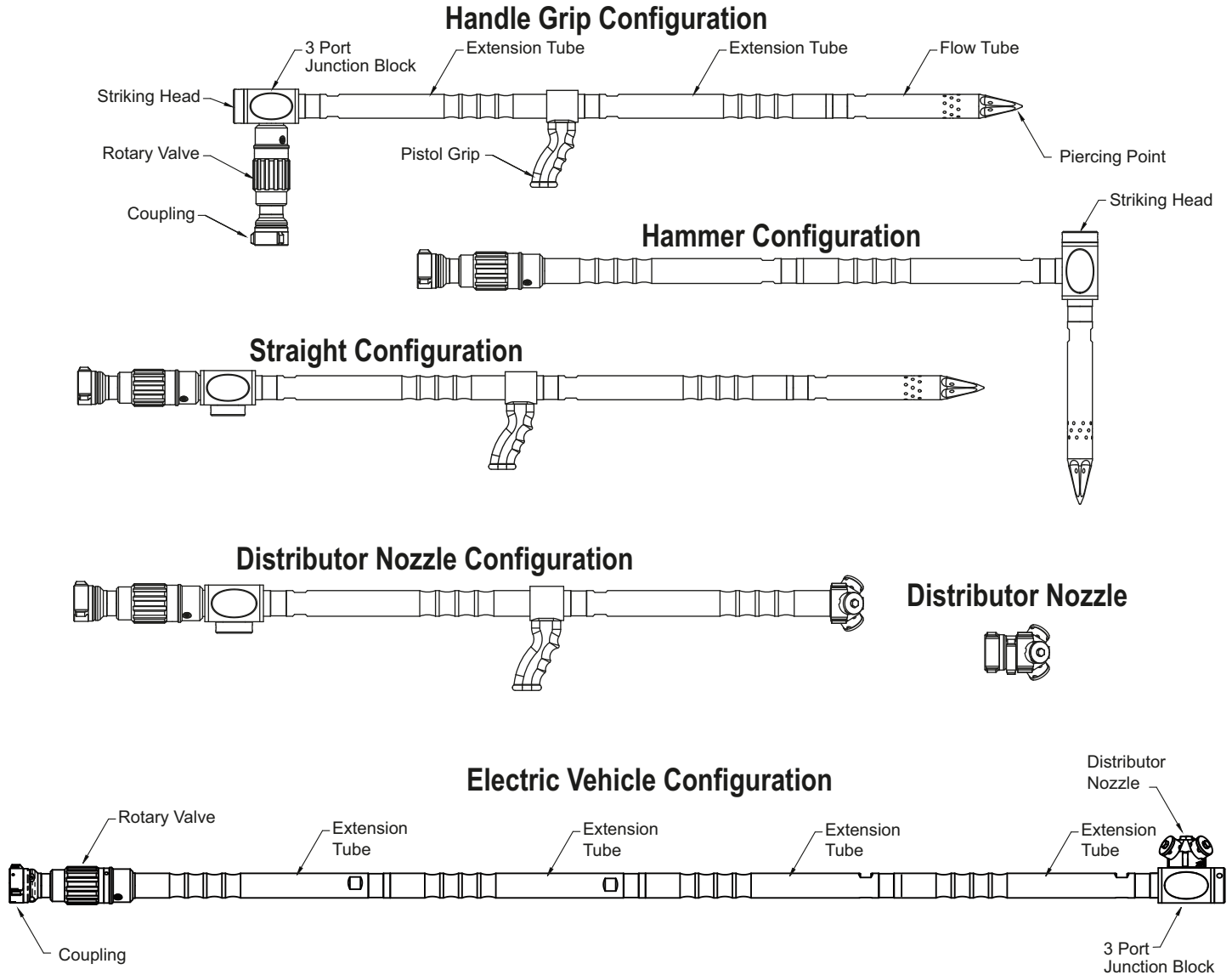

Contact your local dealer or tft.com to purchase additional components.

Figure 3.1

3.2 SPECIFICATIONS

Maximum nozzle inlet pressure with valve shut off	300 psi	21 bar
Operating temperature of fluid	33 to 150°F	1 to 50°C
Storage temperature range	-40 to 150°F	-40 to 65°C
Materials used	Aluminum 6000 series hard anodized MIL 8625 class 3 type 2, stainless steel 300 series, nylon 6-6, nitrile rubber	

Table 3.2

3.3 USE WITH SALT WATER

Use with salt water is permissible provided the equipment is thoroughly cleaned with fresh water after each use. The service life of the equipment may be shortened due to the effects of corrosion, and is not covered under warranty.

3.4 NOZZLE COUPLINGS

NH (National Hose) threads are standard on all nozzles. Other threads such as NPSH (National Pipe Straight Hose) may be specified at time of order.

CAUTION Mismatched or damaged waterway connections may cause equipment to leak or uncouple under pressure. Failure could result in injury. Equipment must be mated to matched connections.

CAUTION Dissimilar metals coupled together can cause galvanic corrosion that can result in the inability to uncouple the connection, or complete loss of engagement over time. Failure could cause injury. Per NFPA 1962, if dissimilar metals are left coupled together, an anti-corrosive lubricant should be applied to the connection and the coupling should be disconnected and inspected at least quarterly.

4.0 NOZZLE CONTROLS

4.1 FLOW CONTROL

NOTICE Control valves must be opened slowly to eliminate unnecessary strain on the hose and couplings, and reduce pressure surges.

NOTICE Nozzles attached to an in-service hose shall be stored in the off position.

4.2 VALVE OPERATION

Each Transformer Nozzle System comes equipped with a unique rotary shutoff valve. The rotary shutoff valve allows the user to operate the Transformer Nozzle System Package without an additional shutoff valve.

From the OFF position, a quarter turn to the left fully opens the waterway. To stop water flow from the ON position, turn the rotary shutoff valve a quarter turn to the right.

WARNING Operating the rotary valve in an intermediate position between ON and OFF may cause the valve position to change unexpectedly, resulting in injury due to an out of control nozzle. To reduce the risk of injury from unexpected valve movement:

- Always be prepared for changes in pressure or flow.
- Always operate the rotary valve in the fully open or fully closed position.

WARNING Large amounts or pieces of debris may be unflushable and can reduce the flow of the nozzle resulting in an ineffective flow. In the event of a blockage, it may be necessary to retreat to a safe area, uncouple the nozzle and remove debris.

****IMPORTANT****

5.0 USING THE TRANSFORMER

The Transformer design puts an emphasis on versatility, light weight, and small package. The use of aluminum tubing and threaded joints allows for a unique lightweight product. The tool that can deliver high water flow rates into tight spaces with a wide range of stream types. While the Transformer can penetrate thin sheet metal such as would be found on a mobile home, or drywall and siding found on a typical home, it is NOT intended to be a primary forcible entry tool. For plywood or other heavy materials, a hole should be created with the pick of a fire axe, then enlarged with the axe until the Transformer can enter with minimal effort.

NOTICE If during an emergency situation where it becomes necessary to drive the Transformer through heavy plywood, steel sheeting or roofing materials without creating a pilot hole, it should be EXPECTED that some damage will occur. The resulting damage is not covered under warranty.

NOTICE Use of the Transformer Nozzle System as a lever or a wedge may cause the unit to bend or fracture. Such damage is considered abuse. The resulting damage is not covered under warranty.

NOTICE Repeated training with the Transformer where it is hammered through difficult materials WILL result in damage to the device and is not a part of the product warranty.

5.1 ASSEMBLY

Due to the modular construction of the Transformer Nozzle System, the user may configure the nozzle in many different arrangements to suit the situation. A few examples are shown in Figure 3.1. Components are assembled by threading together until hand-tight. Additional components are available to further customize the Transformer Nozzle System.



Do not attempt to assemble, disassemble, or configure the Transformer Nozzle System with a pressurized fire hose attached. Safely depressurize and remove the fire hose prior to any assembly or disassembly of the Transformer Nozzle System.



Misaligned, loose, or damaged threads may cause the threaded joints to uncouple under pressure resulting in injury. Nozzle joints must be properly connected. Ensure the threaded joints between components are completely installed and hand tightened. Do not use a wrench to assemble.

5.1.1 STRIKING HEAD

The Transformer Nozzle System uses a removable striking head. The striking head is installed in one of the three threaded holes on the junction block.

To relocate the striking head:

1. Remove the striking head from the port in which it is currently located.
2. Hand tighten the striking head assembly into the chosen port.
3. Turn the striking cap, by hand, beyond the initial contact with the junction block to load the striking cap spring.



Striking the Transformer Nozzle System with a sledge or axe creates risk of injury from missed blows. To reduce risk of injury:

- Always wear protective fire gear, eye protection, and gloves as directed by the AHJ.
- Avoid holding the Transformer Nozzle System in areas likely to be struck by a missed blow.
- Avoid standing in the path of a swinging tool head.
- Avoid striking the Transformer Nozzle System when fatigued beyond one's ability to safely control a swing.
- Exercise sound judgement when operating on sloped, elevated, or slippery surfaces.

NOTICE

The Transformer Nozzle System is designed only to hit on the striking head. Striking in any other location is considered abuse and resulting damage is not covered under warranty.

5.1.2 PIERCING POINT



The piercing point has sharp edges that can cause injury by impalement. Use care when handling and striking the Transformer Nozzle.

- Do not use the Transformer as a pry bar under any circumstance.
- Avoid laying the tool down or storing in a position that presents an impalement or fall hazard.

5.1.3 DISTRIBUTOR NOZZLE

The Task Force Tips Distributor Nozzle distributes water droplets over a large area. The spinners create an interference pattern of water droplets for a dense water pattern. The distributor nozzle attaches to the Transformer Nozzle System and provides additional flexibility to the operator. The distributor nozzle can also couple to fire hose via an available adapter with a 1.5" NH (37 mm) female full time swivel inlet (National Hose Threads per NFPA 1960). The distributor nozzle provides a nominal water flow of 150 GPM at 100 PSI (560 l/min at 7 bar).

NOTICE

Using the distributor nozzle to penetrate obstacles is considered abuse and resulting damage is not covered under warranty. Always create access points with appropriate tools.

6.0 USE WITH FOAM

The nozzle may be used with foam solutions. Refer to fire service training by the Authority Having Jurisdiction (AHJ) for the proper use of foam.



For Class B fires, lack of foam or interruption in the foam stream can cause a break in the foam blanket and greatly increase the risk of injury or death. Follow procedures established by the AHJ for the specific fuel and conditions.



Improper use of foam or using the wrong type of foam can result in illness, injury, or damage to the environment. Follow foam manufacturer's instructions and fire service training as directed by the AHJ.

7.0 WARRANTY

Task Force Tips LLC, 3701 Innovation Way, Valparaiso, Indiana 46383-9327 USA (“TFT”) warrants to the original purchaser of its products (“equipment”), and to anyone to whom it is transferred, that the equipment shall be free from defects in material and workmanship during the five (5) year period from the date of purchase for mechanical components, and the two (2) year period from the date of purchase for electrical components. TFT’s obligation under this warranty is specifically limited to replacing or repairing the equipment (or its parts) which are shown by TFT’s examination to be in a defective condition attributable to TFT. To qualify for this limited warranty, the claimant must return the equipment to TFT, at 3701 Innovation Way, Valparaiso, Indiana 46383-9327 USA, within a reasonable time after discovery of the defect. TFT will examine the equipment. If TFT determines that there is a defect attributable to it, TFT will correct the problem within a reasonable time. If the equipment is covered by this limited warranty, TFT will assume the expenses of repair.

If any defect attributable to TFT under this limited warranty cannot be reasonably cured by repair or replacement, TFT may elect to refund the purchase price of the equipment, less reasonable depreciation, in complete discharge of its obligations under this limited warranty. If TFT makes this election, claimant shall return the equipment to TFT free and clear of any liens and encumbrances.

This is a limited warranty. The original purchaser of the equipment, any person to whom it is transferred, and any person who is an intended or unintended beneficiary of the equipment, shall not be entitled to recover from TFT any consequential or incidental damages for injury to person and/or property resulting from any defective equipment manufactured or assembled by TFT.

It is agreed and understood that the price stated for the equipment is in part consideration for limiting TFT’s liability. Some states do not allow the exclusion or limitation of incidental or consequential damages, so the above may not apply to you.

TFT shall have no obligation under this limited warranty if the equipment is, or has been, misused or neglected (including failure to provide reasonable maintenance) or if there have been accidents to the equipment or if it has been repaired or altered by someone else.

THIS IS A LIMITED EXPRESS WARRANTY ONLY. TFT EXPRESSLY DISCLAIMS WITH RESPECT TO THE EQUIPMENT ALL IMPLIED WARRANTIES OF MERCHANTABILITY AND ALL IMPLIED WARRANTIES OF FITNESS FOR A PARTICULAR PURPOSE. THERE IS NO WARRANTY OF ANY NATURE MADE BY TFT BEYOND THAT STATED IN THIS DOCUMENT.

This limited warranty gives you specific legal rights, and you may also have other rights which vary from state to state.

8.0 MAINTENANCE

TFT products are designed and manufactured to be damage resistant and require minimal maintenance. However, as the primary firefighting tool upon which your life depends, it should be treated accordingly. To help prevent mechanical damage, do not drop or throw equipment.

8.1 FIELD LUBRICATION

All Task Force Tips nozzles are factory lubricated with high quality silicone grease. This lubricant has excellent wash out resistance, providing long term performance. If your agency has unusually hard or sandy water, the moving parts of the nozzle may be affected. Foam agents and water additives contain soaps and chemicals that may break down the factory lubrication.

The moving parts of the nozzle should be checked on a regular basis for smooth and free operation, and for signs of damage. **IF THE NOZZLE IS OPERATING CORRECTLY, THEN NO ADDITIONAL LUBRICANT IS NEEDED.** Any nozzle that is not operating correctly should be immediately removed from service. The nozzle can be returned to the factory at any time for a complete checkup and re-lubrication with silicone grease.

The field use of Break Free CLP (spray or liquid) lubricant will help to temporarily restore the smooth and free operation of the nozzle. These lubricants do not have the washout resistance and long-term performance of the silicone grease. Once Break Free CLP is applied, re-application will be needed on a regular basis until the nozzle can be returned to the factory for a complete checkup and re-lubrication with silicone grease.



Aerosol lubricants contain solvents that can swell O-Rings if applied in excess. The swelling can inhibit smooth operation of the moving parts. When used in moderation, as directed, the solvents quickly evaporate without adversely swelling the O-Rings.

8.2 SERVICE TESTING

In accordance with NFPA 1962, equipment must be tested a minimum of annually. Units failing any part of this test must be removed from service, repaired and retested upon completion of the repair.

8.3 REPAIR

Factory service is available. Factory serviced equipment is repaired by experienced technicians, wet tested to original specifications, and promptly returned. Call TFT service department at 1-800-348-2686 to troubleshoot and, if needed, directions for return. A return for service form can also be obtained at tft.com/Support/Returning-an-Item-for-Service.

Repair parts and service procedures are available for those wishing to perform their own repairs. Task Force Tips assumes no liability for damage to equipment or injury to personnel that is a result of user service. Contact the factory or visit the web site at tft.com for parts lists, exploded views, test procedures and troubleshooting guides.

Performance tests shall be conducted on the equipment after a repair, or anytime a problem is reported to verify operation in accordance with TFT test procedures. Consult factory for the procedure that corresponds to the model and serial number of the equipment. Any equipment which fails the related test criteria should be removed from service immediately. Troubleshooting guides are available with each test procedure or equipment can be returned to the factory for service and testing.



It is the responsibility of service technicians to ensure the use of appropriate protective clothing and equipment. The chosen protective clothing and equipment must provide protection from potential hazards users may encounter while servicing equipment. Requirements for protective clothing and equipment are determined by the Authority Having Jurisdiction (AHJ).



Any alterations to the product or its markings could diminish safety and constitutes a misuse of this product.



All replacement parts must be obtained from the manufacturer to assure proper performance and operation of the device.

9.0 EXPLODED VIEWS AND PARTS LISTS

Exploded views and parts lists are available at tft.com/serial-number.

10.0 OPERATION AND INSPECTION CHECKLIST

BEFORE EACH USE, the nozzle must be inspected to this checklist:

1. There is no obvious damage such as missing, broken or loose parts, etc.
2. Waterway and nozzle jets are clear of obstructions
3. Nozzle flow is adequate as indicated by pump pressure and nozzle reaction
4. Threaded joints between components are hand-tight and leak free
5. Coupling is tight and leak free
6. Valve operates freely through full range and regulates flow
7. "OFF" position shuts off fully and flow is stopped

BEFORE BEING PLACED BACK IN SERVICE, nozzles must be inspected to this checklist:

1. All controls and adjustments are operational
2. Shut off valve closes off the flow completely
3. There are no broken or missing parts
4. There is no damage to the nozzle that could impair safe operation (e.g. dents, cracks, corrosion or other defects)
5. The thread gasket is in good condition
6. The waterway is clear of obstructions
7. Nozzle is clean and markings are legible
8. Coupling is tightened properly
9. Shutoff handle is stored in the OFF position



Equipment failing any part of the checklist is unsafe for use and must have the problem corrected before use or being placed back into service. Operating equipment that has failed the checklist is a misuse of this equipment.