

INSTRUCTIONS FOR INSTALLATION, OPERATION, AND MAINTENANCE

⚠ WARNING

Understand manual before use. Operation of this device without understanding the manual and receiving proper training is a misuse of this equipment. Obtain safety information at tft.com/serial-number.

This equipment is intended for use by trained and qualified emergency services personnel for firefighting. All personnel using this equipment shall have completed a course of education approved by the Authority Having Jurisdiction (AHJ).

This instruction manual is intended to familiarize firefighters and maintenance personnel with the operation, servicing, and safety procedures associated with this product. This manual should be kept available to all operating and maintenance personnel.

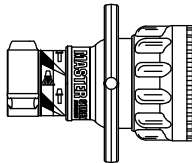

MASTERSTREAM 1000
150 - 1000 GPM @ 100 PSI
600 - 4000 L/min @ 7 BAR (700 kPa)

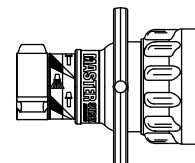

MASTERSTREAM 1250S
150 - 1250 GPM @ 100 PSI
600 - 4500 L/min @ 7 BAR (700 kPa)

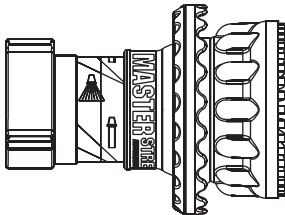

MASTERSTREAM 1250
300 - 1250 GPM @ 70 - 120 PSI
1100 - 4700 L/min @ 4.8 - 8.3 BAR (480 - 830 kPa)

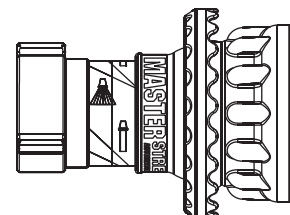

MASTERSTREAM 1500
300 - 1500 GPM @ 70 - 120 PSI
1100 - 5700 L/min @ 4.8 - 8.3 BAR (480 - 830 kPa)

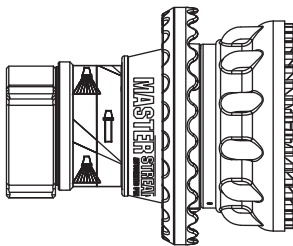

MASTERSTREAM 2000
300 - 2000 GPM @ 80 - 120 PSI
1100 - 7600 L/min @ 5.5 - 8.3 BAR (550 - 830 kPa)

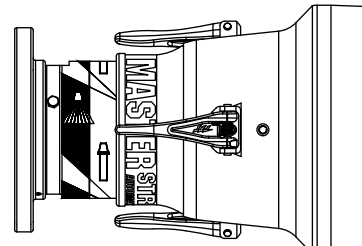

MASTERSTREAM 4000
600 - 4000 GPM @ 80 - 120 PSI
2300 - 15000 L/min @ 5.5 - 8.3 BAR (550 - 830 kPa)

SUPPORTING MATERIALS

The following documents contain supporting safety and operating information pertaining to the equipment described in this manual.

TASK FORCE TIPS
FIRE FIGHTING EQUIPMENT

MANUAL: Foam Aspirators

INSTRUCTIONS FOR SAFE OPERATION AND MAINTENANCE

WARNING Intentional misuse of this equipment is prohibited. Operation of this device without understanding the manual and receiving proper training is a misuse of this equipment. Obtain safety information at all times.

This instruction manual is intended to familiarize firefighters and maintenance personnel with the operation, setting, and safety procedures associated with this device. This manual should be kept available to all operating and maintenance personnel.

FoamJet

FoamJet-LX

MX-FoamJet

FJ-LX-M

MX-FoamJet

MX-FoamJet

MX Foam Nozzle

FJ-LX-M2

TASK FORCE TIPS LLC
MADE IN USA • www.tft.com

3701 Innovation Way, Valparaiso, IN 46383-9327 USA
800-348-2686 • 219-462-6161 • Fax 219-464-7155

Copyright Task Force Tips, Inc. 2020

LIA-025
Manual: Foam Aspirators

TASK FORCE TIPS
FIRE FIGHTING EQUIPMENT

NOZZLE TRAJECTORY ELEVATION FACTORS

Reach Factor (compared to 30° elevation)

Stream reach and height at non-optimal elevations can be estimated as a factor of the performance of the optimal 30° elevation. Refer to LIM-025 and LIM-026 for effective stream trajectories of Task Force Tips Masterstream nozzles at 30° elevation. The graph cannot be used to estimate maximum reach for elevation angles below 30°.

10 To estimate elevation angle when vertical and horizontal distances to target are known:

- 1.1 Find the maximum height and reach at 30° from the appropriate trajectory curve in LIM-025 or LIM-026.
- 1.2 Calculate the Height Factor by dividing the vertical distance to the target by maximum height from step 1.1.
- 1.3 Calculate the Reach Factor by dividing the horizontal distance to the target by maximum reach from step 1.1.
- 1.4 On the graph of nozzle trajectory elevation factors, find the intersection of the Height Factor and Reach Factor from steps 1.2 and 1.3. If this point lies on or between the curves given, estimate the appropriate elevation angle. If this point lies within the shaded region of the graph, then a higher flow or pressure must be used to reach the target.

20 To estimate maximum reach for a given elevation angle above 30°:

- 2.1 From the graph of nozzle trajectory elevation factors, choose the trajectory curve for the desired elevation angle.
- 2.2 Find the point where this trajectory curve intersects the height of discharge (zero height line).
- 2.3 Estimate the Reach Factor at this point using the scale across the top of the graph.
- 2.4 Multiply this Reach Factor by the reach at 30° elevation from the appropriate trajectory curve in LIM-025 or LIM-026.

30 To estimate maximum height for a given elevation angle above 30°:

- 3.1 From the graph of nozzle trajectory elevation factors, choose the trajectory curve for the desired elevation angle.
- 3.2 Find the maximum height on this trajectory curve.
- 3.3 Estimate the Height Factor at the maximum height using the scale on the left side of the graph.
- 3.4 Multiply this Height Factor by the height at 30° elevation from the appropriate trajectory curve in LIM-025 or LIM-026.

TASK FORCE TIPS, INC.
MADE IN USA • www.tft.com

3701 Innovation Way, Valparaiso, IN 46383-9327 USA
800-348-2686 • 219-462-6161 • Fax 219-464-7155

Copyright Task Force Tips, Inc. 2020

LTT-135
Nozzle Trajectory Elevation Factors

TASK FORCE TIPS
FIRE FIGHTING EQUIPMENT

TASK FORCE TIPS ELECTRIC REMOTE NOZZLES
ELECTRIC REMOTE WIRING DIAGRAM

LEGEND

[] SWITCH DPDT 5 AMP MIN.
[] MOMENTARY ON, CENTER OFF
[] CIRCUIT BREAKER - NOT INCLUDED WITH NOZZLE
1.5 MFL, 1.5 AMP, 24 VOLT FOR 12 & 24 VDC SYSTEM
1.5 MFL, 1.5 AMP, 24 VOLT FOR 24 & 36 VDC SYSTEM
[] WATERPROOF CORD CONNECTOR
[] OPTIONAL - WATERPROOF CORD CONNECTOR OR WATER RESISTANT PLUG AND RECEPTACLE

LEADS
R = RED
G = GREEN
W = WHITE
B = BLACK

TASK FORCE TIPS LLC
MADE IN USA • www.tft.com

3701 INNOVATION WAY, VALPARAISO, IN 46383-9327
(800) 348-2686 (219) 462-6161 FAX (219) 464-7155

Copyright Task Force Tips, Inc. 2020

LIM-040
ER Nozzle Wiring Guide

TASK FORCE TIPS
FIRE FIGHTING EQUIPMENT

MANUAL: Remote Control (RC) Monitor Electrical Controls

Supplemental Instructions for use with RC Monitor Manual

INSTRUCTIONS FOR INSTALLATION, SAFE OPERATION AND MAINTENANCE

Understand manual before use. Operation of this device without understanding the manual and receiving proper training is a misuse of this equipment. Obtain safety information at www.tft.com.

SECTION 3.0
General Information and Specifications

SECTION 4.0
Electrical Controls Installation and Operation

SECTION 4.1
Monitor Mounted Operator Station

SECTION 4.2
Panel Mount Operator Station (YAE-OP)

SECTION 4.3
Panel Mount With Display Operator Station (YAE-OP-D)

SECTION 4.4
Tethered Operator Station (YAE-CT-#)

SECTION 4.5
Tethered Operator Station With Display (YAE-CT-#-D)

SECTION 4.6
Wireless Operator Station (YAE-OP-W)

SECTION 4.7
Wireless Operator Station With Display (YAE-OP-W-D)

SECTION 4.8
Joystick Operator Station (YAE-JS)

SECTION 4.9
Toggle Switch Monitor Operator Station (YAE-TS)

SECTION 4.10
Monitor Communication Interface Control (YAE-COMM)

SECTION 4.11
Monitor Position Display (YAE-DISP)

SECTION 4.12
Remote Auxiliary Function Interface Control (YAE-REMAUX)

SECTION 4.13
Electric RC Monitor Aerial Truck Installation

SECTION 4.14
Multiple Interface Control (YAE-CAN)

SECTION 4.15
Ethernet Interface Control

SECTION 4.16
Electric Nozzle Actuator

SECTION 4.17
Voice Aids (YAE-W-PA)

SECTION 5.0
Troubleshooting

TASK FORCE TIPS LLC
MADE IN USA • www.tft.com

3701 Innovation Way, Valparaiso, IN 46383-9327 USA
800-348-2686 • 219-462-6161 • Fax 219-464-7155

Copyright Task Force Tips, Inc. 2020

LIY-500
Manual: Remote Control (RC) Monitor Electrical Controls

TABLE OF CONTENTS

- 1.0 MEANING OF SAFETY SIGNAL WORDS
- 2.0 SAFETY
- 3.0 GENERAL INFORMATION
 - 3.1 VARIOUS MODELS AND TERMS
 - 3.2 SPECIFICATIONS
 - 3.3 NOZZLE COUPLINGS
 - 3.4 USE WITH SALT WATER
 - 3.5 HYDRAULIC INSTALLATION
 - 3.6 ELECTRIC INSTALLATION
- 4.0 FLOW CHARACTERISTICS
 - 4.1 MASTERSTREAM 1000 & 1250S (AUTOMATIC)
 - 4.2 MASTERSTREAM 1250, 1500, 2000, & 4000 (AUTOMATIC)
 - 4.3 MASTERSTREAM 1000 (SELECTABLE)
 - 4.4 MASTERSTREAM 1000 (FIXED)
 - 4.5 REACH AND TRAJECTORY
- 5.0 OPERATION
 - 5.1 PATTERN CONTROL
 - 5.2 FLUSHING DEBRIS
- 6.0 USE WITH FOAM
 - 6.0.1 FOAMJET LX WITH MASTERSTREAM 1000 AND 1250S NOZZLE
- 7.0 WARRANTY
- 8.0 MAINTENANCE
 - 8.1 FIELD LUBRICATION
 - 8.2 SERVICE TESTING
 - 8.3 REPAIR
- 9.0 EXPLODED VIEWS AND PARTS LISTS
- 10.0 OPERATION AND INSPECTION CHECKLIST

DANGER

PERSONAL RESPONSIBILITY CODE

The member companies of FEMSA that provide emergency response equipment and services want responders to know and understand the following:

1. Firefighting and Emergency Response are inherently dangerous activities requiring proper training in their hazards and the use of extreme caution at all times.
2. **IT IS YOUR RESPONSIBILITY** to read and understand any user's instructions, including purpose and limitations, provided with any piece of equipment you may be called on to use.
3. **IT IS YOUR RESPONSIBILITY** to know that you have been properly trained in Firefighting and/or Emergency Response and in the use, precautions, and care of any equipment you may be called upon to use.
4. **IT IS YOUR RESPONSIBILITY** to be in proper physical condition and to maintain the personal skill level required to operate any equipment you may be called upon to use.
5. **IT IS YOUR RESPONSIBILITY** to know that your equipment is in operable condition and has been maintained in accordance with the manufacturer's instructions.
6. Failure to follow these guidelines may result in death, burns or other severe injury.





Fire and Emergency Manufacturers and Service Association, Inc.
PO Box 147, Lynnfield, MA 01940 - www.FEMSA.org

FEMSA

© 2020 FEMSA. All Rights Reserved.









1.0 MEANING OF SAFETY SIGNAL WORDS

A safety related message is identified by a safety alert symbol and a signal word to indicate the level of risk involved with a particular hazard. Per ANSI Z535.6, the definitions of the four signal words are as follows:

	DANGER indicates a hazardous situation which, if not avoided, will result in death or serious injury.
	WARNING indicates a hazardous situation which, if not avoided, could result in death or serious injury.
	CAUTION indicates a potentially hazardous situation which, if not avoided, could result in minor or moderate injury.
	NOTICE is used to address practices not related to physical injury.

2.0 SAFETY

OPERATING NOTE ABOUT AUTOMATIC NOZZLES: The automatic nozzle is considerably different than Fixed and Selectable Flow nozzles because of basic changes in the operating principle. These differences not only assure the most effective operation under a variety of conditions, but will also utilize the available water supply most efficiently. It is important that nozzle operators, pump operators, and officers be fully aware of these differences. Therefore, proper instruction is required for safe and effective operations.

	DANGER An inadequate supply of pressure and/or flow will cause an ineffective stream and can result in injury or death. Choose operating conditions to deliver adequate fire suppression. See flow graphs.
	WARNING This equipment is intended for use by trained personnel for firefighting. Use of this equipment for other purposes may involve hazards not addressed by this manual. Seek appropriate guidance and training to reduce risk of injury.
	WARNING Injury or damage can occur from an inadequately supported monitor. The mounting must be capable of supporting the nozzle reaction force which can be as high as 1500 lbs.
	WARNING Some volatile liquids can be ignited by static discharge, which can occur during application of foam or water. Fire or explosion can result in injury or death. Follow procedures established by the AHJ to reduce risk of fire or explosion caused by static discharge.
	WARNING Application of water or foam solutions on energized electrical equipment could cause electrocution. Serious injury or death could result. Assume circuits are energized until confirmed to be de-energized. Do not apply water or foam to energized electrical equipment.
	WARNING The stream exiting a nozzle is very powerful and capable of causing injury and property damage. Make sure the nozzle is securely attached and pointing in a safe direction before water is turned on. Do not direct water stream to cause injury or damage to persons or property.
	WARNING Equipment may be damaged if frozen while containing significant amounts of water. Such damage may be difficult to detect visually. Subsequent pressurization can lead to injury or death. Any time the equipment is subject to possible damage due to freezing, it must be tested and approved for use by qualified personnel before being considered safe for use.
	NOTICE To prevent mechanical damage, do not drop or throw equipment.

3.0 GENERAL INFORMATION

The Task Force Tips Masterstream Series nozzles are deluge nozzles with clean, far reaching straight stream capability. They are adjustable from straight stream to a dense fog pattern.

The Task Force Tips Masterstream Series Nozzles automatic nozzles operate by sensing the pressure at the nozzle inlet and adjusting the discharge opening to maintain a constant pressure throughout the flow range of the nozzle. While flowing, the stream pattern can be varied from wide fog to straight stream. Trapped debris can be removed without the use of tools.

3.1 VARIOUS MODELS AND TERMS

AUTOMATIC SERIES	FLOW RANGE		NOMINAL PRESSURE		STANDARD COUPLING
	GPM	L/min	PSI	BAR, kPa/ 100	
MASTERSTREAM 1000	150-1000	600-4000	100	7	2.5" NH FEMALE
MASTERSTREAM 1250S	150-1250	600-4500	100	7	2.5" NH FEMALE
MASTERSTREAM 1250	300-1250	1100-4700	70-120	4.8-8.3	2.5" NH FEMALE or 3.5" NH FEMALE
MASTERSTREAM 1500	300-1500	1100-5700	70-120	4.8-8.3	2.5" NH FEMALE or 3.5" NH FEMALE
MASTERSTREAM 2000	300-2000	1100-7600	80-120	5.5-8.3	3.5" NH FEMALE
MASTERSTREAM 4000	600-4000	2350-15000	80-120	5.5-8.3	6.0" ANSI 150 FLANGE

FIXED/SELECTABLE SERIES	FLOW		PRESSURE		K FACTOR	STANDARD COUPLING
	GPM	L/min	PSI	BAR, kPa/100		
MASTERSTREAM 1000 FIXED	CUSTOMER SPECIFIED 1000 GPM MAX	CUSTOMER SPECIFIED 4000 L/min MAX	CUSTOMER SPECIFIED 150 PSI MAX	CUSTOMER SPECIFIED 10 BAR MAX	50-100	2.5" NH FEMALE
MASTERSTREAM 1000 SELECTABLE	250, 350, 500, 750, 1000	1000, 1500, 2000, 3000, 4000	100	7	15-75	2.5" NH FEMALE
MASTERSTREAM 1250 SELECTABLE	300, 500, 700, 1000, 1250	1200, 1800, 2400, 3600, 4800	150	10	50-105	2.5" NH FEMALE

NOTES ON ABOVE TABLE

- Other threads, coupling sizes, or connector styles can be specified at time of order.
- Masterstream 1250, 1500, 2000, and 4000 nozzles are field adjustable within the range of pressures shown.
- For long term installations, it is recommended that the threads be greased before installing the nozzle.

3.1 VARIOUS MODELS AND TERMS (CONTINUED)

The spray pattern is changed from wide fog to straight stream by means of the “stream shaper”. Models are available with six different methods to move the stream shaper as shown.

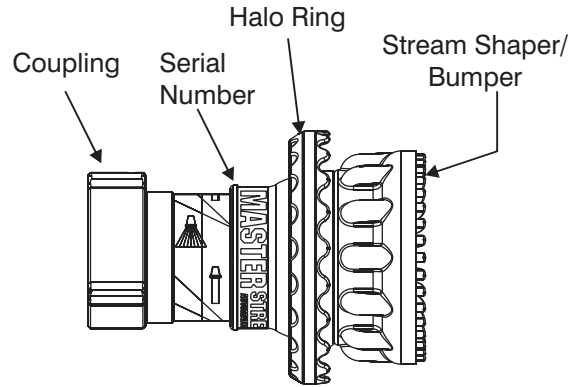

Stream Shaper moved manually
by rotating the Halo Ring or Bumper

Figure 3.1A

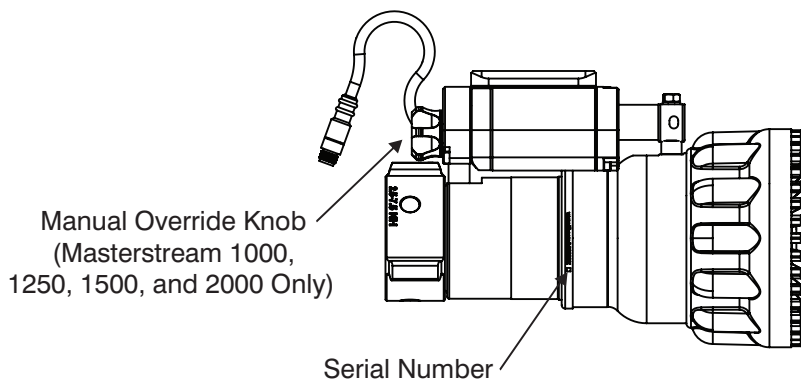

Manual Override Knob
(Masterstream 1000,
1250, 1500, and 2000 Only)

Stream Shaper moved
remotely by electricity (12-24 volts)

Figure 3.1B

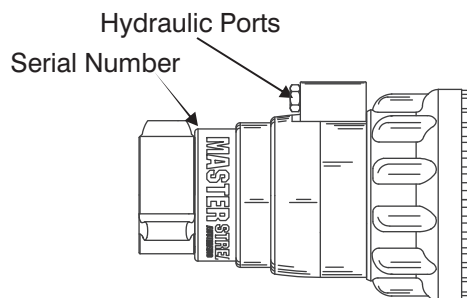

Stream Shaper moved remotely
by hydraulics

Figure 3.1C

3.2 SPECIFICATIONS

	US	METRIC
Operating temperature of fluid	33 to 120°F	1 to 50°C
Storage temperature range	-40 to 150°F	-40 to 65°C
Materials used	Aluminum 6000 series hard anodized MIL 8625 class 3 type 2, stainless steel 300 series, nylon 6-6, nitrile rubber	

Table 3.2

3.3 NOZZLE COUPLINGS

NH (National Hose) threads are standard on all nozzles. Other threads such as NPSH (National Pipe Straight Hose) may be specified at time of order.

CAUTION Mismatched or damaged waterway connections may cause equipment to leak or uncouple under pressure. Failure could result in injury. Equipment must be mated to matched connections.

CAUTION Dissimilar metals coupled together can cause galvanic corrosion that can result in the inability to uncouple the connection, or complete loss of engagement over time. Failure could cause injury. Per NFPA 1962, if dissimilar metals are left coupled together, an anti-corrosive lubricant should be applied to the connection and the coupling should be disconnected and inspected at least quarterly.

3.4 USE WITH SALT WATER

Use with salt water is permissible provided the equipment is thoroughly cleaned with fresh water after each use. The service life of the equipment may be shortened due to the effects of corrosion, and is not covered under warranty.

3.5 HYDRAULIC INSTALLATION

On nozzles with hydraulic stream shaper actuation, the hydraulic system is connected to the nozzle with two 1/8"-27 NPT female ports on the filter block located on the nozzle's stream shaper. When the port on the left of the filter block (as seen from behind the nozzle) is pressurized, the shaper moves back into the wide fog position. Pressurizing the right port moves the shaper forward into straight stream. Hydraulic lines must be flexible to allow for movement of the stream shaper. Use only clean fluid compatible with Buna N Compound (Nitrile). System must be free from all dirt, chips and contaminants. Replacement filter elements are available from TFT (item #M160). Maximum hydraulic pressure is 1000 psi (70 bar, 7000 kPa) for Masterstream 1000 or 1250s.

3.6 ELECTRIC INSTALLATION

Nozzles with electric stream shaper actuation are shipped with a wiring diagram (TFT item #LIM-040). Other documentation is available on request. ER nozzles are equipped with manual override in case of electrical power failure.

WARNING This device is not rated as ignition proof, explosion proof, or intrinsically safe. Use only in locations with adequate ventilation and no hazard of flammable vapor buildup.

4.0 FLOW CHARACTERISTICS

4.1 MASTERSTREAM 1000 & 1250S (AUTOMATIC)

Within its flow range, the Masterstream 1000 and 1250s automatic nozzles operate at the nominal pressure of 100 PSI (7 BAR, 700 kPa). The following figures show typical performance of this nozzle.

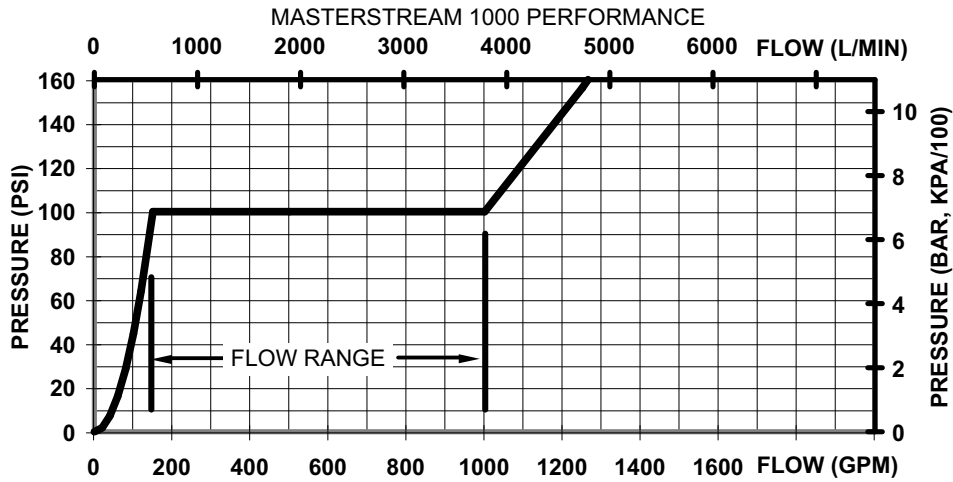

Figure 4.1A

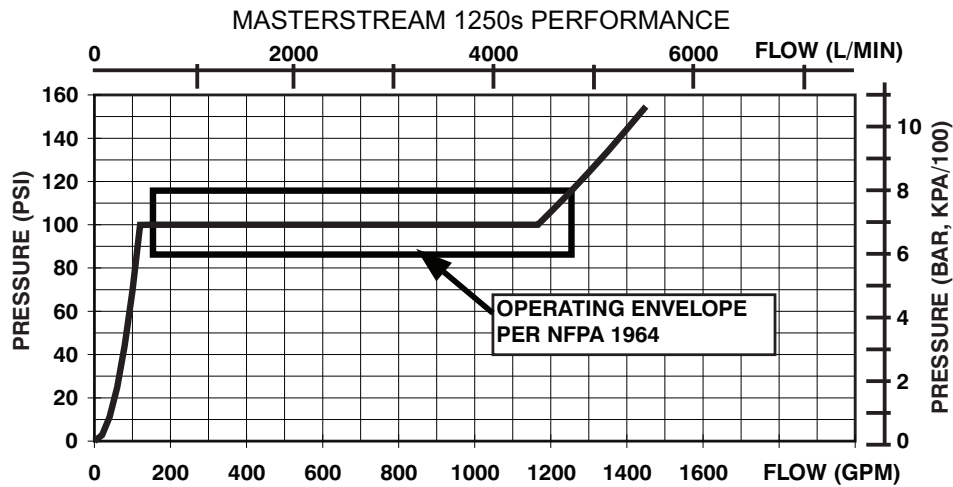

Figure 4.1B

4.2 MASTERSTREAM 1250, 1500, 2000, & 4000 (AUTOMATIC)

The operating pressure of these nozzles is user adjustable. Pressure adjustment is performed by twisting a knob on the front of the nozzle to the desired pressure setting. The following figures show typical flow performance for each model when adjusted to marked pressure settings. The automatic pressure control will maintain the set pressure anywhere within the flow ranges shown on the graphs, which vary according to pressure setting.

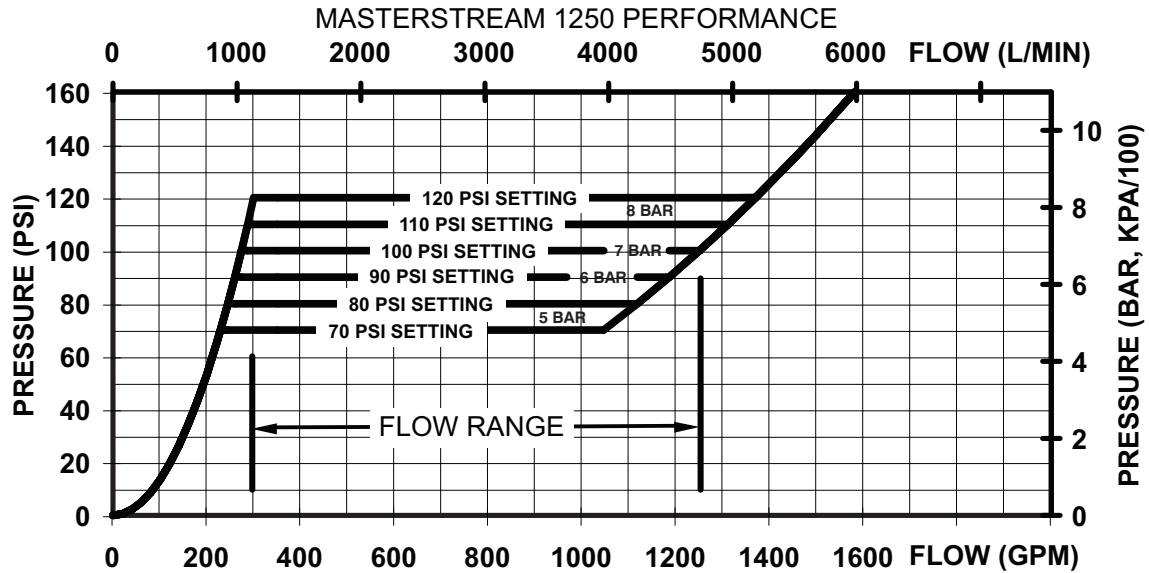
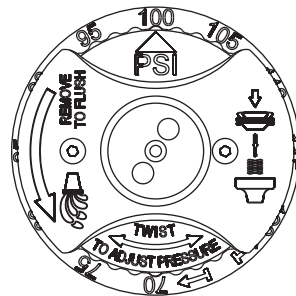

Figure 4.2A



To adjust the Master 1250 and 1500, simply twist the pressure adjustment knob to the desired detent setting.

Figure 4.2B

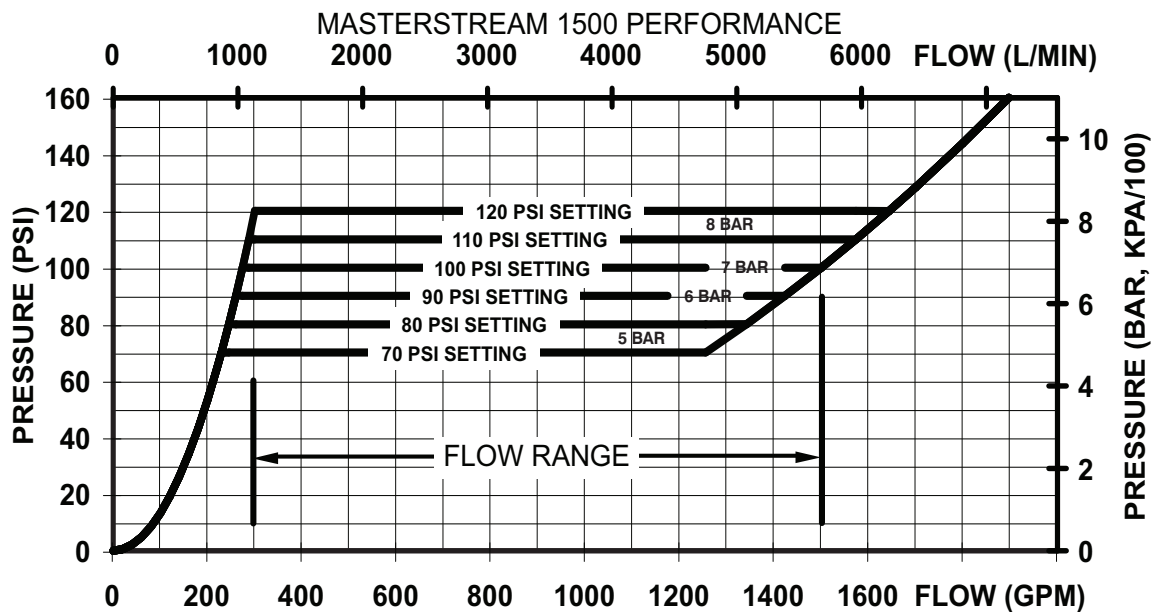

Figure 4.2C

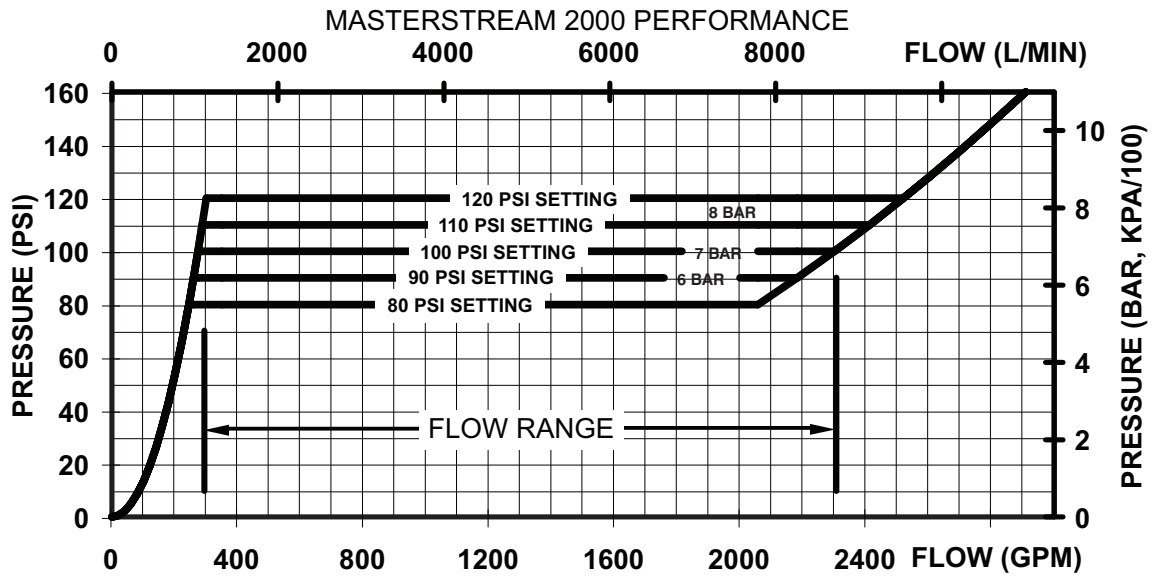

Figure 4.2D

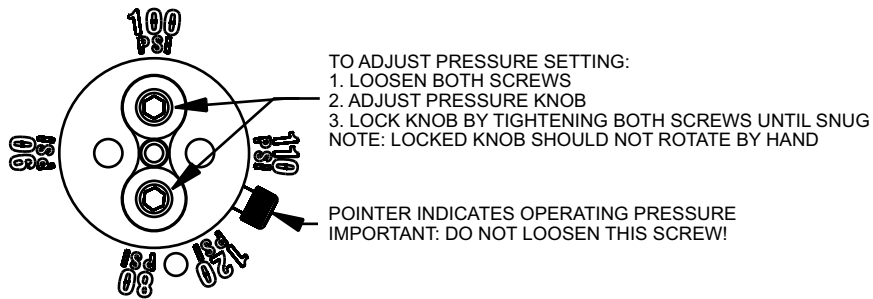

Figure 4.2E

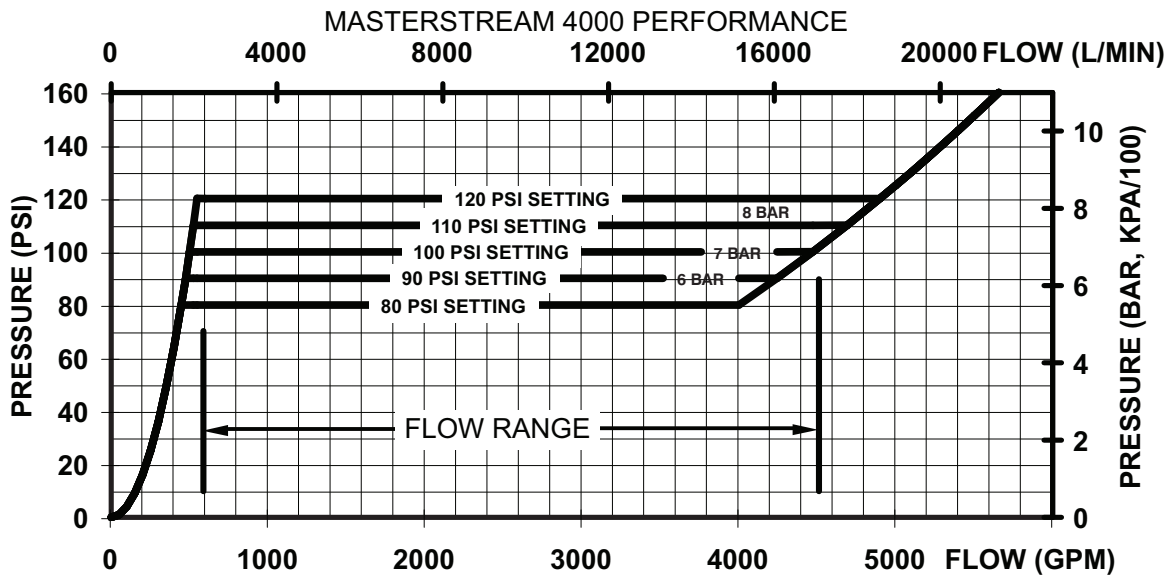

Figure 4.2F

4.3 MASTERSTREAM 1000 (SELECTABLE)

The Masterstream 1000 Selectable Nozzle allows the user to select one of several orifice sizes by turning a knob at the front of the nozzle. An indicator on the knob shows which flow has been selected. The figure below gives relationship of flow and pressure for various orifice size.

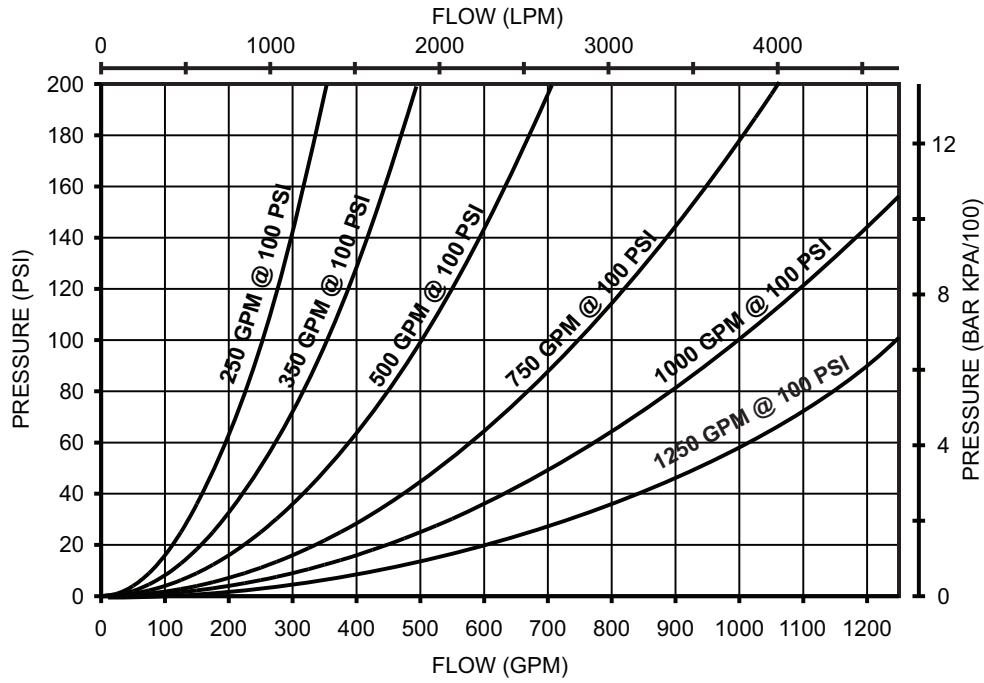

Figure 4.3

4.4 MASTERSTREAM 1000 (FIXED)

The Masterstream 1000 Fixed Flow Nozzle is set to the desired flow by adjusting the baffle and locking it in place with a jam nut. The nozzle is adjusted and flow tested at the factory at time of order. If the baffle is moved (for example to flush the nozzle), then the baffle must be readjusted to obtain the desired flow. Refer to Figure 3.2 for baffle position to achieve a certain flow and pressure. The figure below gives relationship of flow and pressure for various orifice sizes.

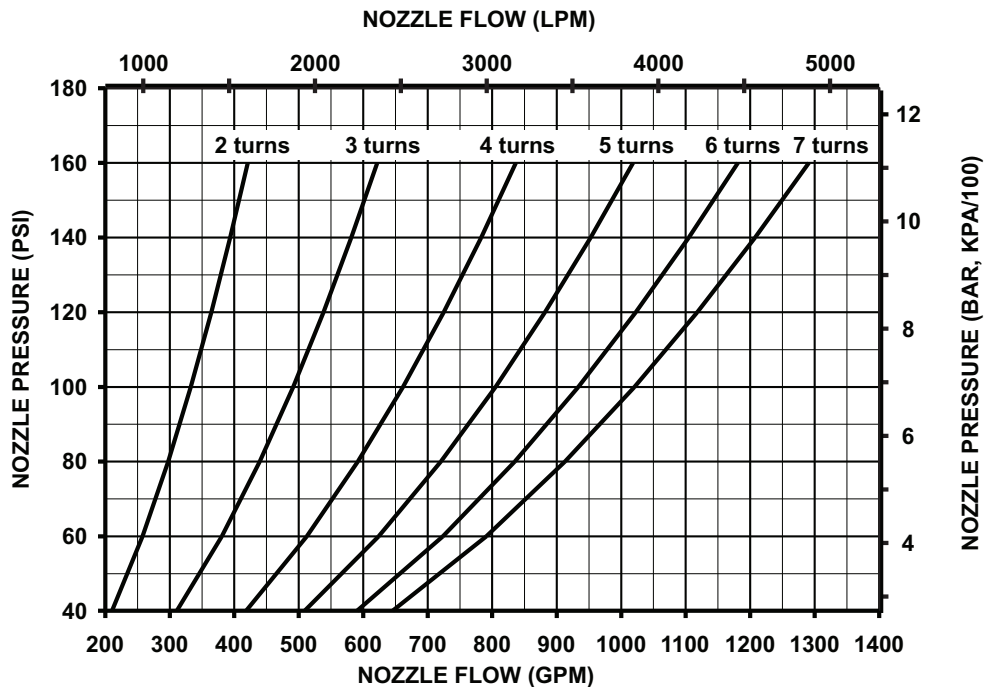

Figure 4.4

4.5 REACH AND TRAJECTORY



Dents or nicks in the nozzle tip can seriously affect the stream reach or pattern, which may increase the risk of injury due to exposure. Care must be taken to avoid dents or nicks in the nozzle tip.

Notes on trajectory graphs:

- Graphs show approximate effective stream trajectory at 30 degrees elevation in no wind conditions. Distance to last water drops approximately 10% farther.
- To estimate trajectories at elevations other than 30 degrees, refer to document LTT-135, available at tft.com.
- Trajectories shown are for water. The addition of foam is expected to decrease the reach by 10%.
- Tail or head winds of 20 MPH (30 KPH) may increase or decrease the range approximately 30%.

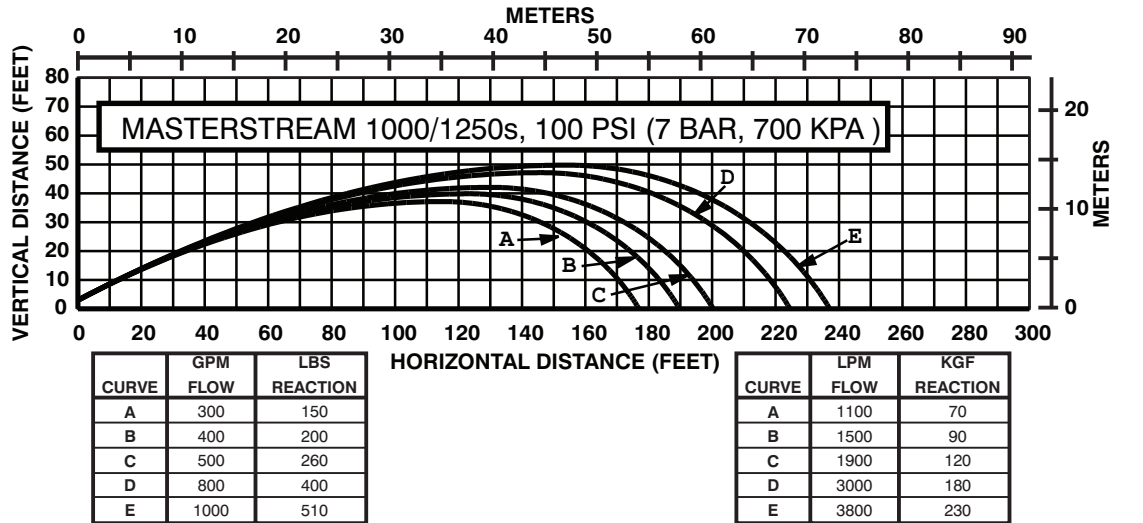

Figure 4.5A

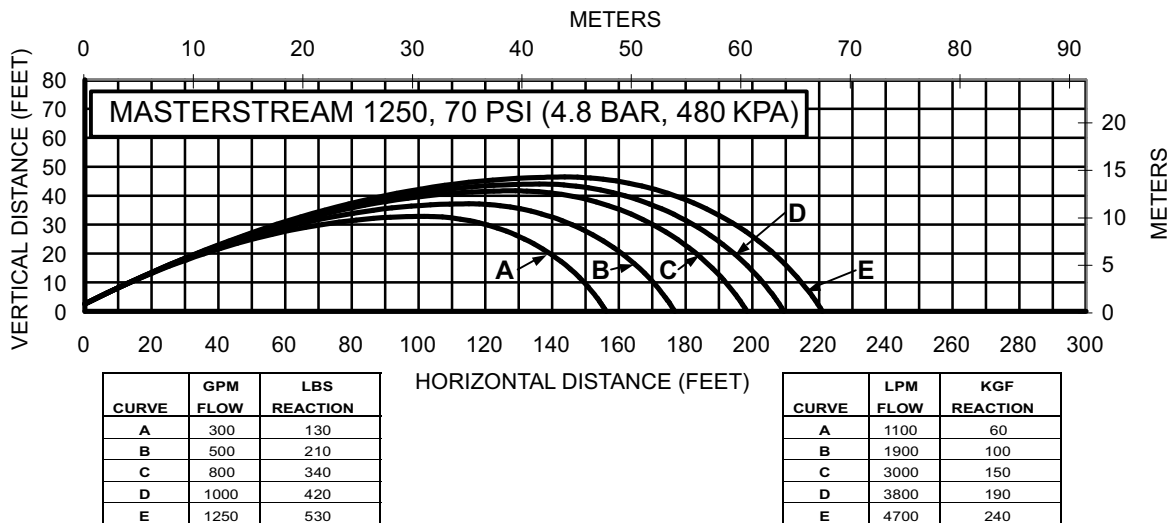

Figure 4.5B

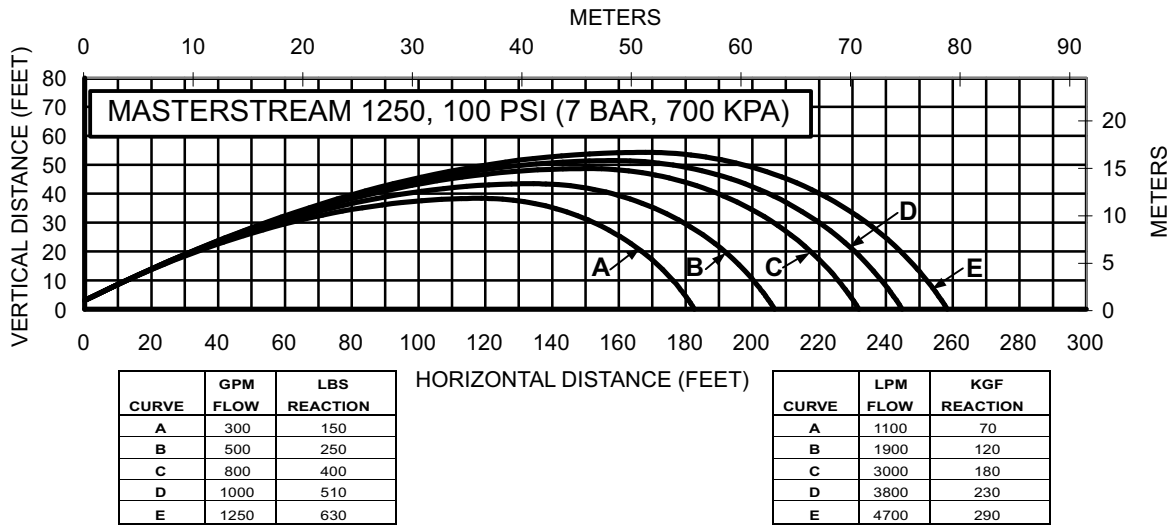

Figure 4.5C

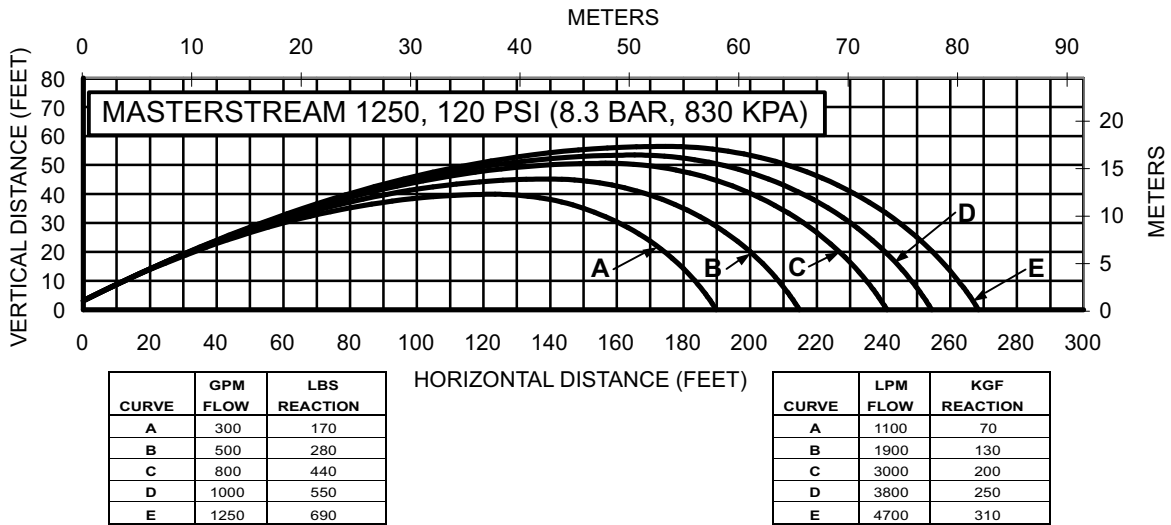

Figure 4.5D

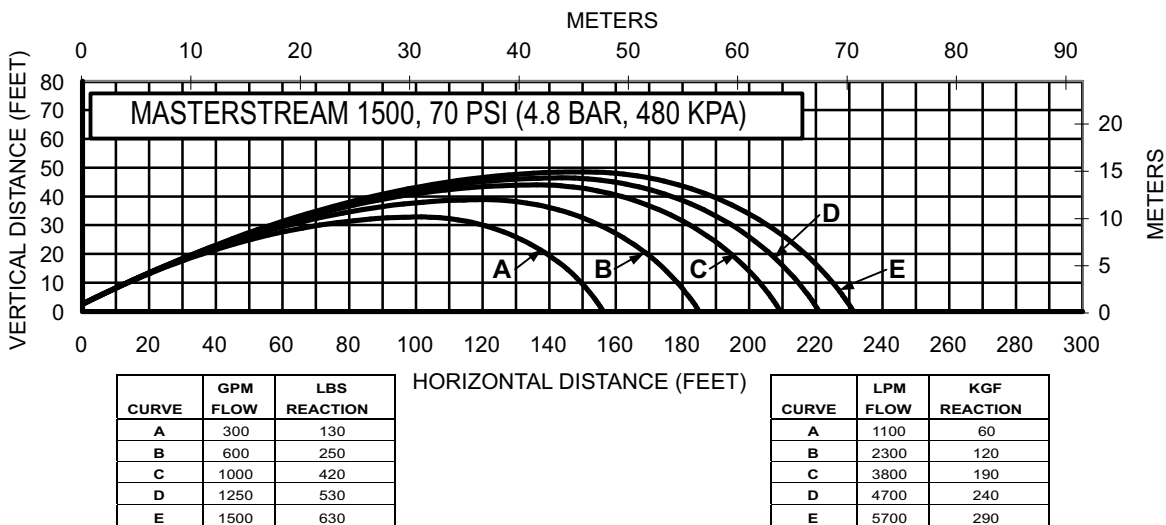

Figure 4.5E

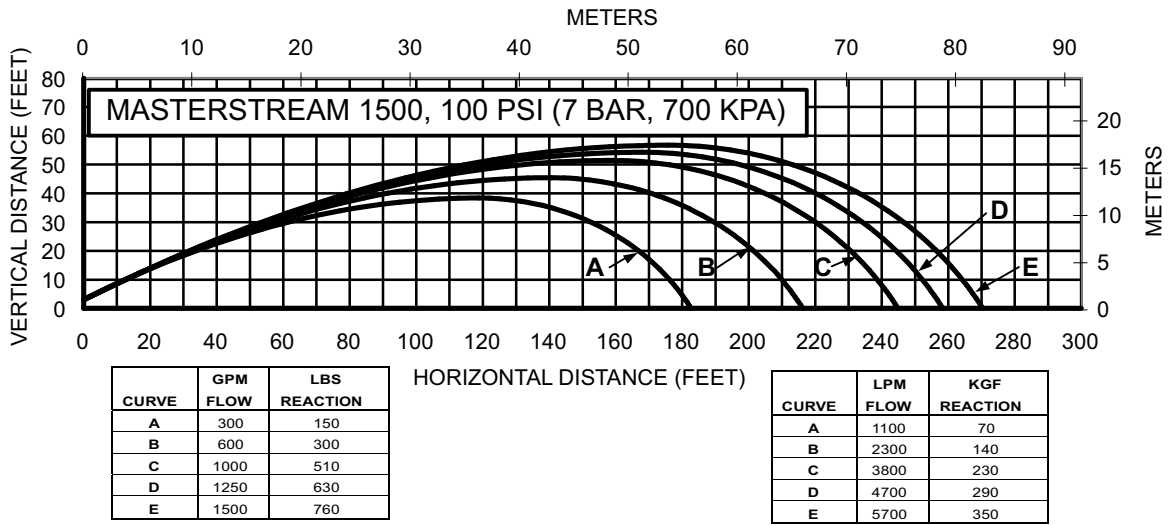

Figure 4.5F

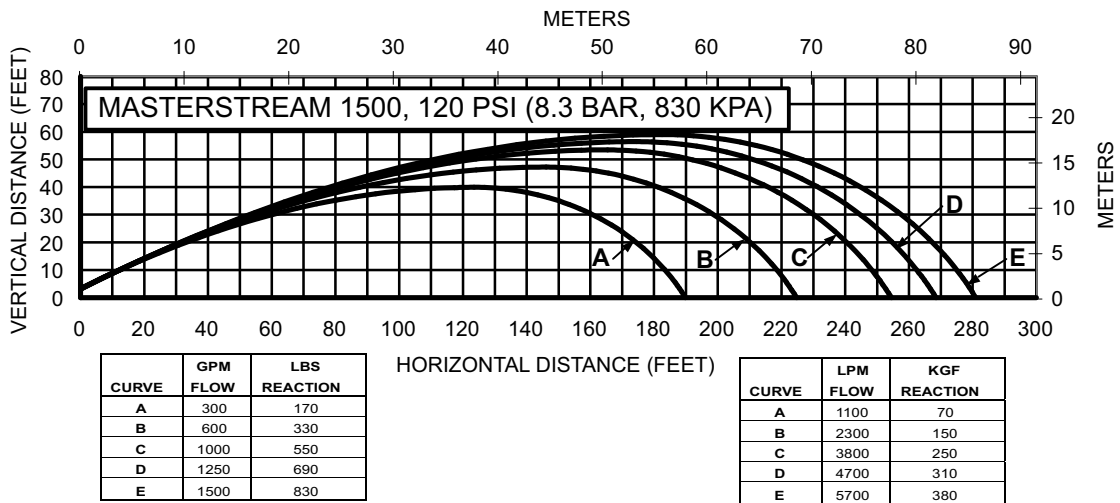

Figure 4.5G

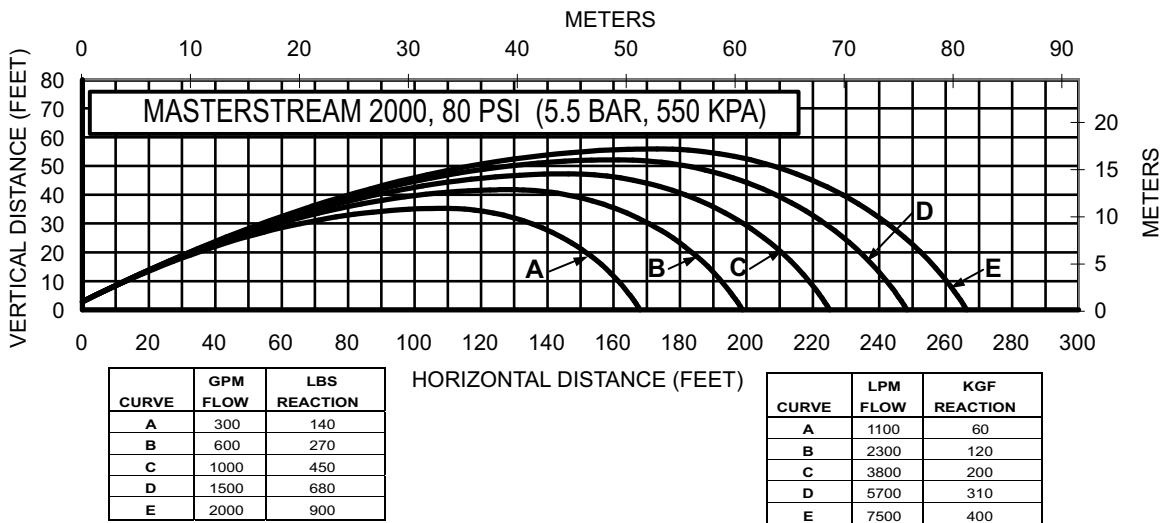

Figure 4.5H

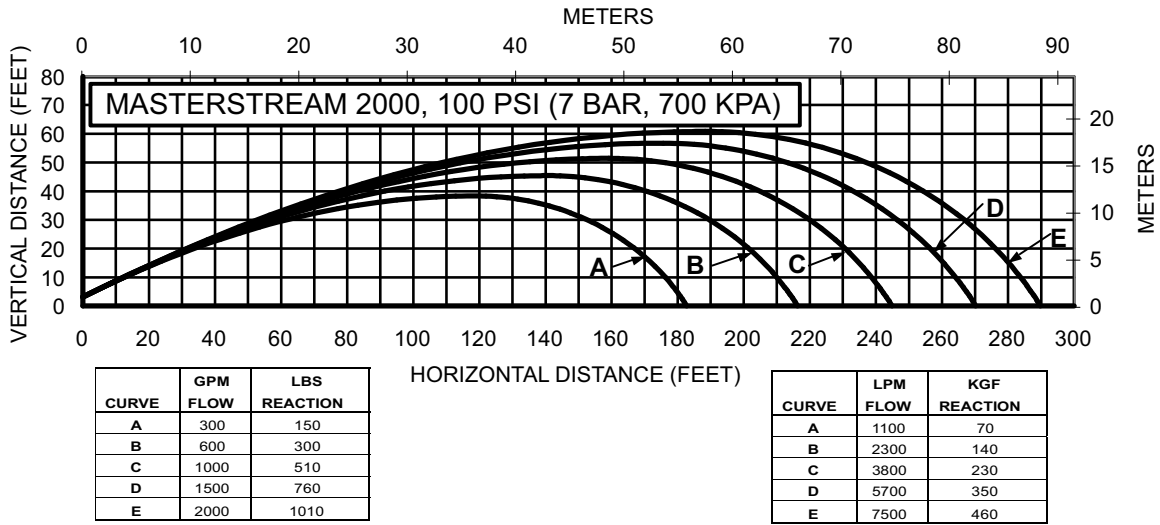

Figure 4.5I

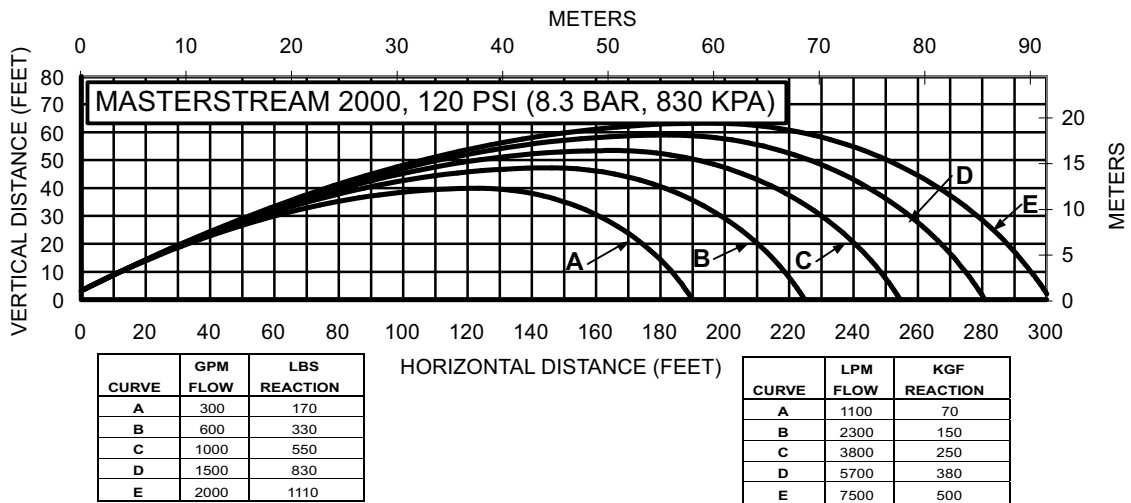

Figure 4.5J

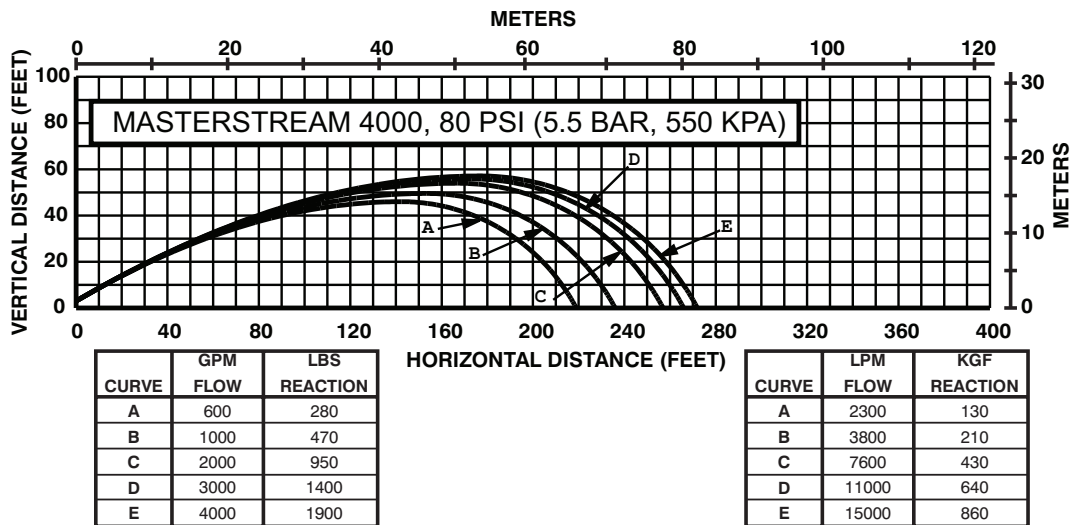

Figure 4.5K

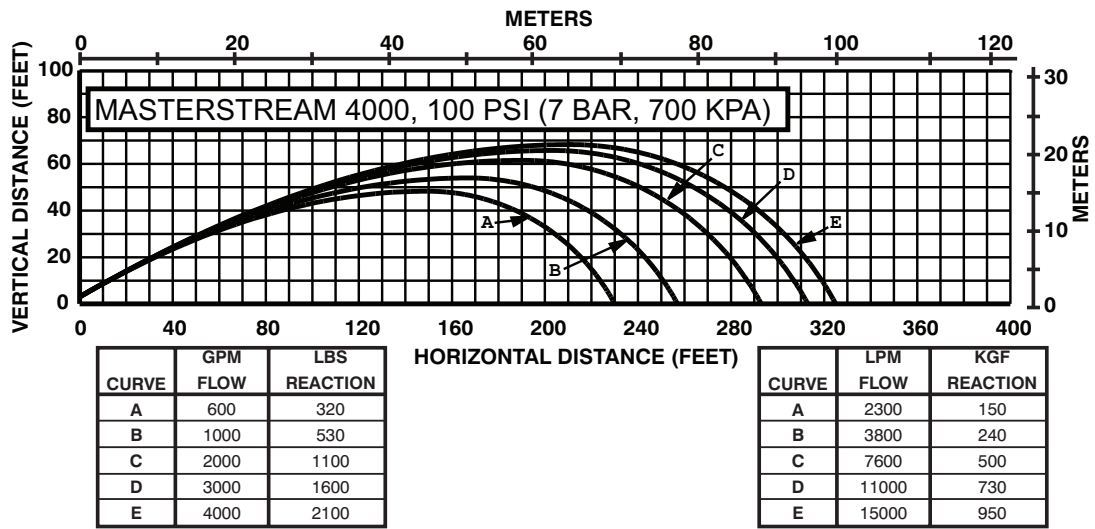

Figure 4.5L

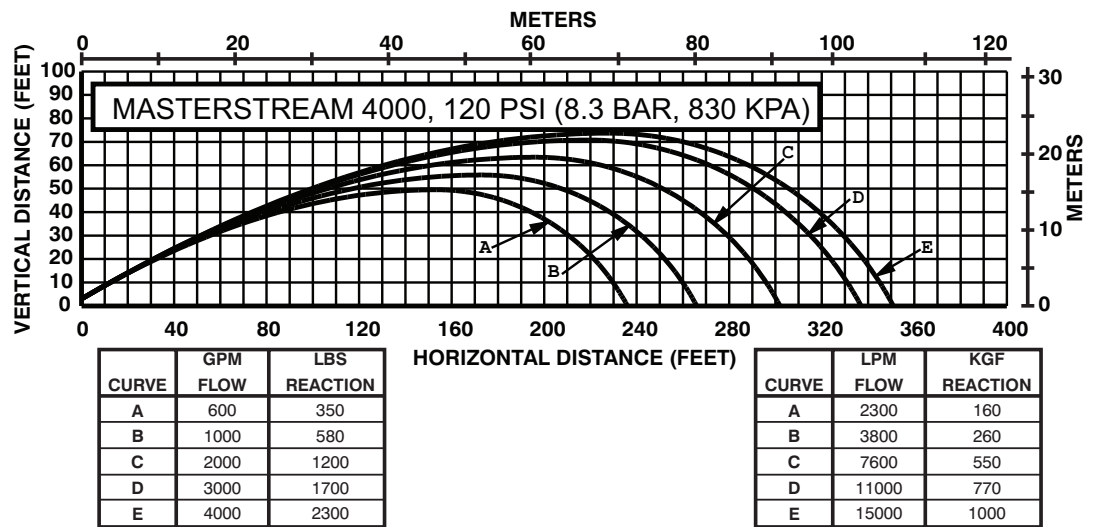

Figure 4.5M

5.0 OPERATION

5.1 PATTERN CONTROL

TFT's Masterstream with Flush Series nozzles have full pattern control from straight stream to wide fog.

On models with manual shapers, turning the stream shaper clockwise (as seen from the operating position behind the nozzle) moves the shaper to the straight stream position.

On ER models, press and hold the FOG or STRAIGHT STREAM button until the desired pattern is obtained.

Since the stream trim point varies with flow, the nozzle should be "trimmed" after changing the flow to obtain the straightest and farthest reaching stream. To properly trim a stream, first open the pattern to narrow fog. Then close the stream to parallel to give maximum reach. Note: Turning the shaper further forward will cause stream crossover and reduce the effective reach of the nozzle.

5.2 FLUSHING DEBRIS

Debris in the water may get caught inside the nozzle. This trapped material will cause poor stream quality, shortened reach and reduced flow. To remove debris trapped in the nozzle:

1. Shut off flow to the nozzle.
2. Move the stream shaper to the wide fog position.

For Selectable Nozzles: Turn flow selector on front to "FLUSH" position.

For Fixed Nozzles: Remove nozzle to gain access.

For Automatic Nozzles: Carefully unscrew and remove the piston/cylinder.

Notes for 1000 and 1250s Nozzles:

- The cylinder is under about 25 lbs (11Kgf) of spring force. The spring must be compressed to reinstall.
- A long white push rod is part of the cylinder assembly. Pull cylinder straight out until push rod clears shaft.

Notes for 1250, 1500, 2000 and 4000 Nozzles:

- Remove the piston, return spring and cylinder.
 - Remove the small spring and stainless steel poppet from the center of the shaft as a unit.
1. Remove/flush debris. Flow water if necessary.
 2. Reassemble the nozzle.

The following figures show the pieces that are removed during the flush procedure of the various Automatic nozzles.



Large amounts or pieces of debris may be unflushable and can reduce the flow of the nozzle resulting in an ineffective flow. In the event of a blockage, it may be necessary to retreat to a safe area, uncouple the nozzle and remove debris.

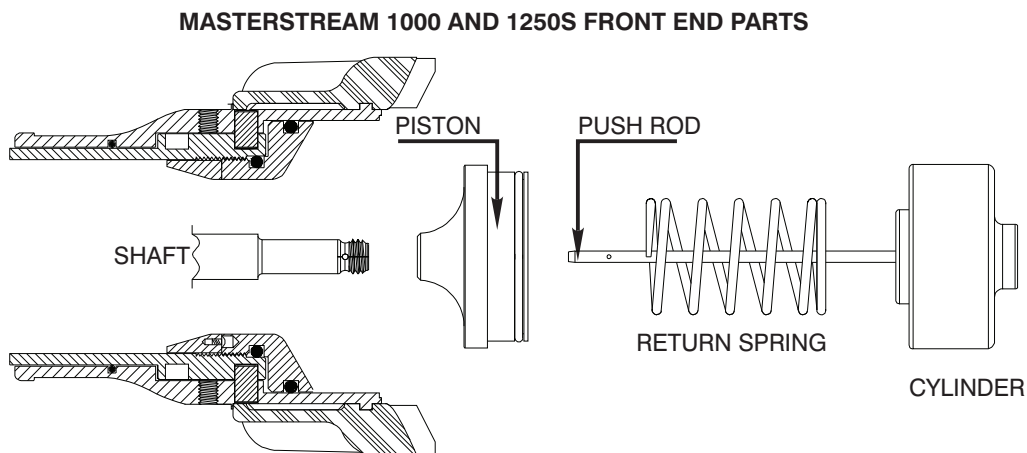

MASTERSTREAM 1250 AND 1500 FRONT END PARTS

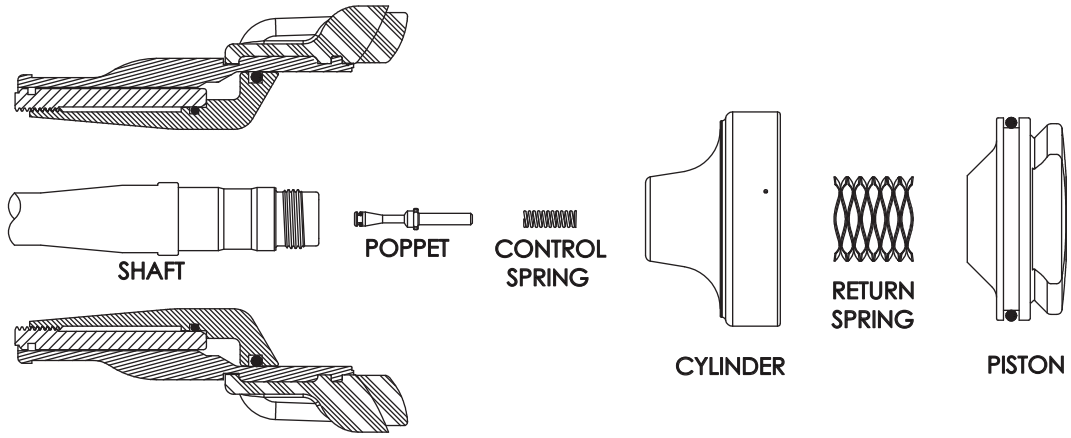

Figure 5.2B

MASTERSTREAM 2000 FRONT END PARTS

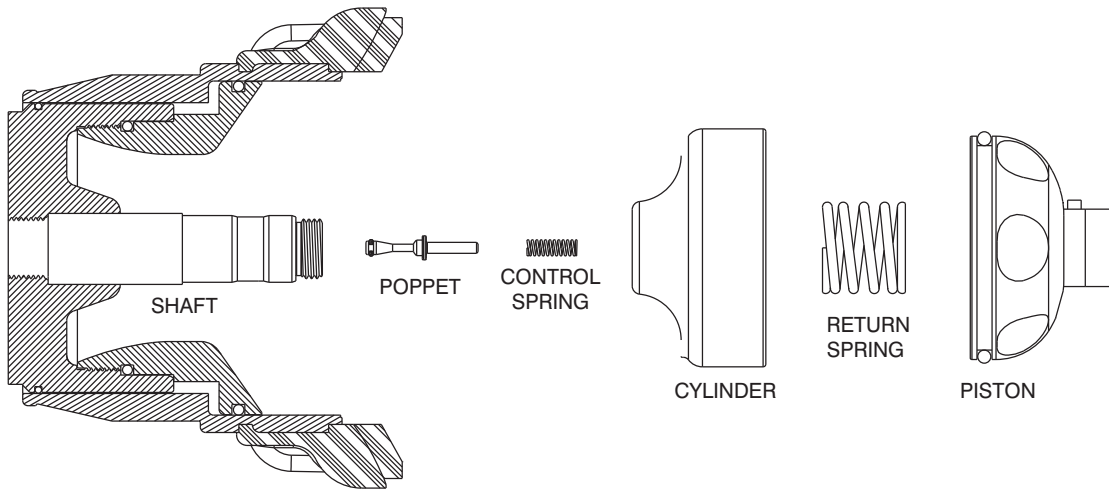

Figure 5.2C

MASTERSTREAM 4000 FRONT END PARTS

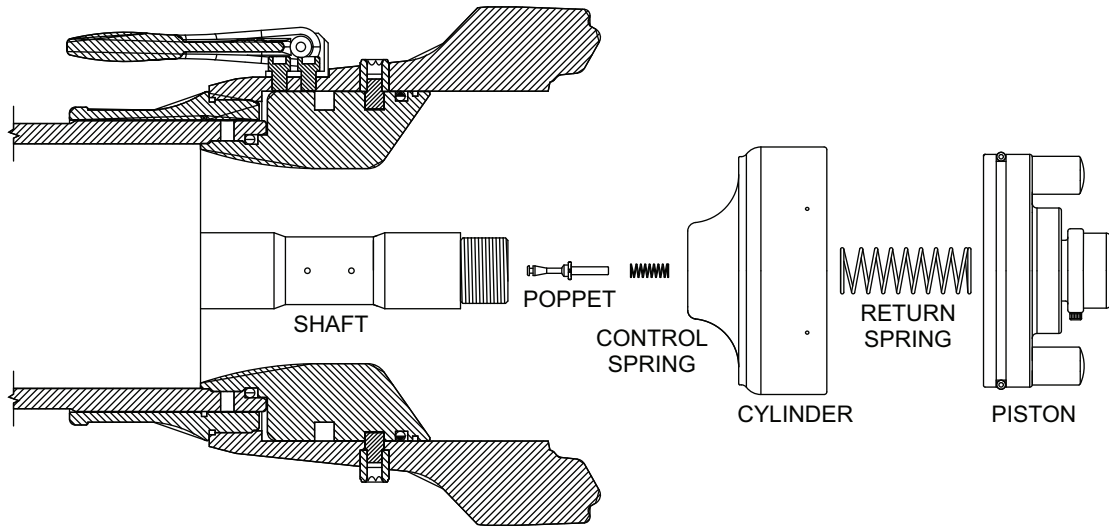

Figure 5.2D

6.0 USE WITH FOAM

The nozzle may be used with foam solutions. Refer to fire service training by the Authority Having Jurisdiction (AHJ) for the proper use of foam.



For Class B fires, lack of foam or interruption in the foam stream can cause a break in the foam blanket and greatly increase the risk of injury or death. Follow procedures established by the AHJ for the specific fuel and conditions.



Improper use of foam or using the wrong type of foam can result in illness, injury, or damage to the environment. Follow foam manufacturer's instructions and fire service training as directed by the AHJ.

6.0.1 FOAMJET LX WITH MASTERSTREAM 1000 AND 1250S NOZZLE

To increase the expansion ratio, Task Force Tips "Foamjet LX" (model FJ-LX-M) may be used with the Masterstream 1000 and 1250s nozzles. This low expansion foam tube attaches and detaches quickly from the nozzle. Adjust nozzle spray pattern to give best foam quality. Note: As expansion ratio is increased, the reach of the nozzle will be decreased due to the greater amount of bubbles in the stream and their inability to penetrate the air. The reach with foam is approximately 10% less than with water only. Actual results will vary based on brand of foam, hardness of water, temperature, etc.

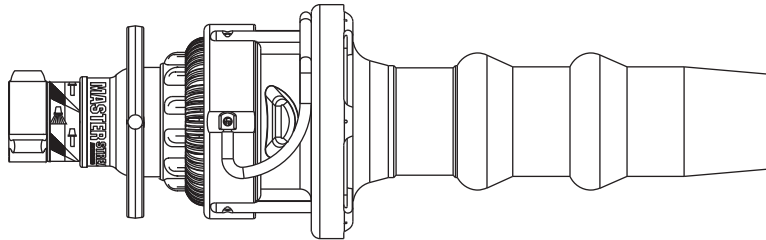

Figure 6.0.1

7.0 WARRANTY

Task Force Tips LLC, 3701 Innovation Way, Valparaiso, Indiana 46383-9327 USA ("TFT") warrants to the original purchaser of its products ("equipment"), and to anyone to whom it is transferred, that the equipment shall be free from defects in material and workmanship during the five (5) year period from the date of purchase for mechanical components, and the two (2) year period from the date of purchase for electrical components. TFT's obligation under this warranty is specifically limited to replacing or repairing the equipment (or its parts) which are shown by TFT's examination to be in a defective condition attributable to TFT. To qualify for this limited warranty, the claimant must return the equipment to TFT, at 3701 Innovation Way, Valparaiso, Indiana 46383-9327 USA, within a reasonable time after discovery of the defect. TFT will examine the equipment. If TFT determines that there is a defect attributable to it, TFT will correct the problem within a reasonable time. If the equipment is covered by this limited warranty, TFT will assume the expenses of repair.

If any defect attributable to TFT under this limited warranty cannot be reasonably cured by repair or replacement, TFT may elect to refund the purchase price of the equipment, less reasonable depreciation, in complete discharge of its obligations under this limited warranty. If TFT makes this election, claimant shall return the equipment to TFT free and clear of any liens and encumbrances.

This is a limited warranty. The original purchaser of the equipment, any person to whom it is transferred, and any person who is an intended or unintended beneficiary of the equipment, shall not be entitled to recover from TFT any consequential or incidental damages for injury to person and/or property resulting from any defective equipment manufactured or assembled by TFT.

It is agreed and understood that the price stated for the equipment is in part consideration for limiting TFT's liability. Some states do not allow the exclusion or limitation of incidental or consequential damages, so the above may not apply to you.

TFT shall have no obligation under this limited warranty if the equipment is, or has been, misused or neglected (including failure to provide reasonable maintenance) or if there have been accidents to the equipment or if it has been repaired or altered by someone else.

THIS IS A LIMITED EXPRESS WARRANTY ONLY. TFT EXPRESSLY DISCLAIMS WITH RESPECT TO THE EQUIPMENT ALL IMPLIED WARRANTIES OF MERCHANTABILITY AND ALL IMPLIED WARRANTIES OF FITNESS FOR A PARTICULAR PURPOSE. THERE IS NO WARRANTY OF ANY NATURE MADE BY TFT BEYOND THAT STATED IN THIS DOCUMENT.

This limited warranty gives you specific legal rights, and you may also have other rights which vary from state to state.

8.0 MAINTENANCE

TFT products are designed and manufactured to be damage resistant and require minimal maintenance. However, as the primary firefighting tool upon which your life depends, it should be treated accordingly. To help prevent mechanical damage, do not drop or throw equipment.

8.1 FIELD LUBRICATION

All Task Force Tips nozzles are factory lubricated with high quality silicone grease. This lubricant has excellent wash out resistance, providing long term performance. If your agency has unusually hard or sandy water, the moving parts of the nozzle may be affected. Foam agents and water additives contain soaps and chemicals that may break down the factory lubrication.

The moving parts of the nozzle should be checked on a regular basis for smooth and free operation, and for signs of damage. **IF THE NOZZLE IS OPERATING CORRECTLY, THEN NO ADDITIONAL LUBRICANT IS NEEDED.** Any nozzle that is not operating correctly should be immediately removed from service. The nozzle can be returned to the factory at any time for a complete checkup and re-lubrication with silicone grease.

The field use of Break Free CLP (spray or liquid) lubricant will help to temporarily restore the smooth and free operation of the nozzle. These lubricants do not have the washout resistance and long-term performance of the silicone grease. Once Break Free CLP is applied, re-application will be needed on a regular basis until the nozzle can be returned to the factory for a complete checkup and re-lubrication with silicone grease.

CAUTION Aerosol lubricants contain solvents that can swell O-Rings if applied in excess. The swelling can inhibit smooth operation of the moving parts. When used in moderation, as directed, the solvents quickly evaporate without adversely swelling the O-Rings.

To access lubrication points in the control unit:

1. Shut off flow to the nozzle.
2. Move the Stream Shaper to the wide fog position.
3. Carefully unscrew the Piston/Cylinder.
 - The Cylinder is under about 25 lbs (11Kgf) of spring force. The spring must be compressed to reinstall.
4. Remove the Piston, Return Spring, and Cylinder.
5. Lubricate the points indicated.
6. Reassemble the nozzle.

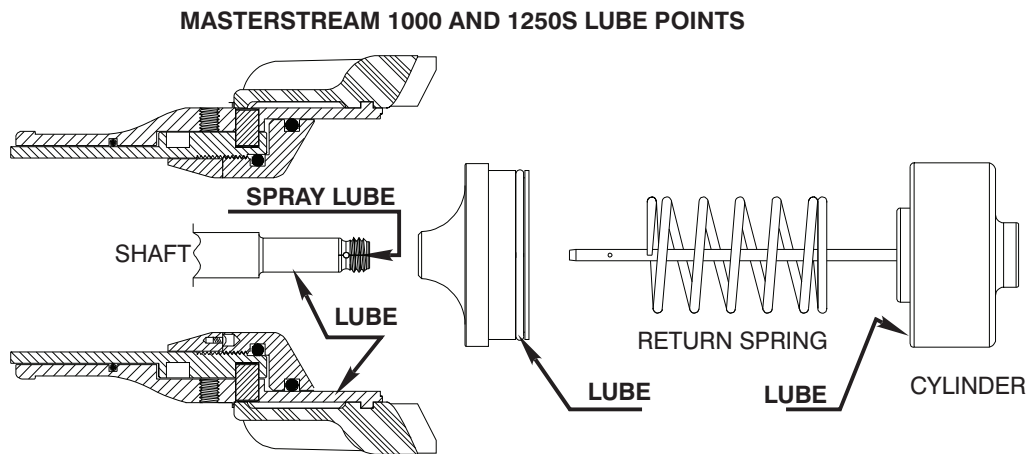

Figure 8.1A

MASTERSTREAM 1250 AND 1500 LUBE POINTS

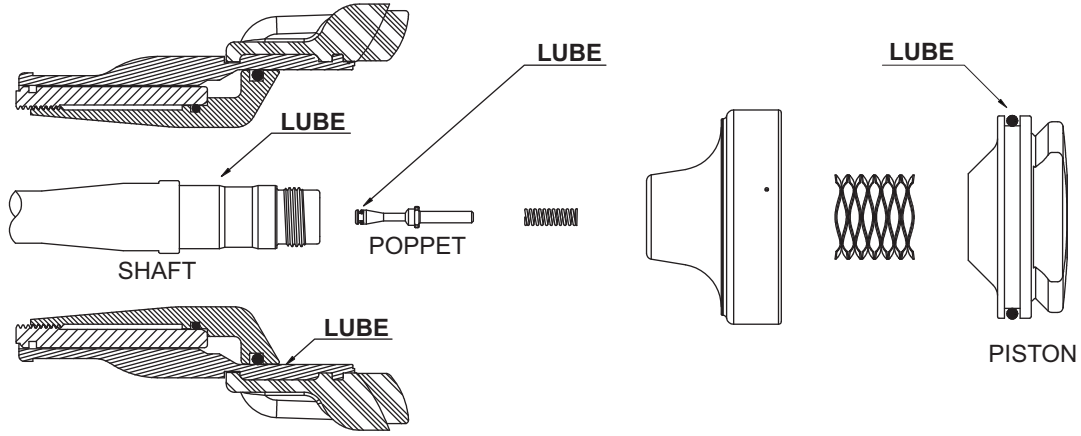

Figure 8.1B

MASTERSTREAM 2000 LUBE POINTS

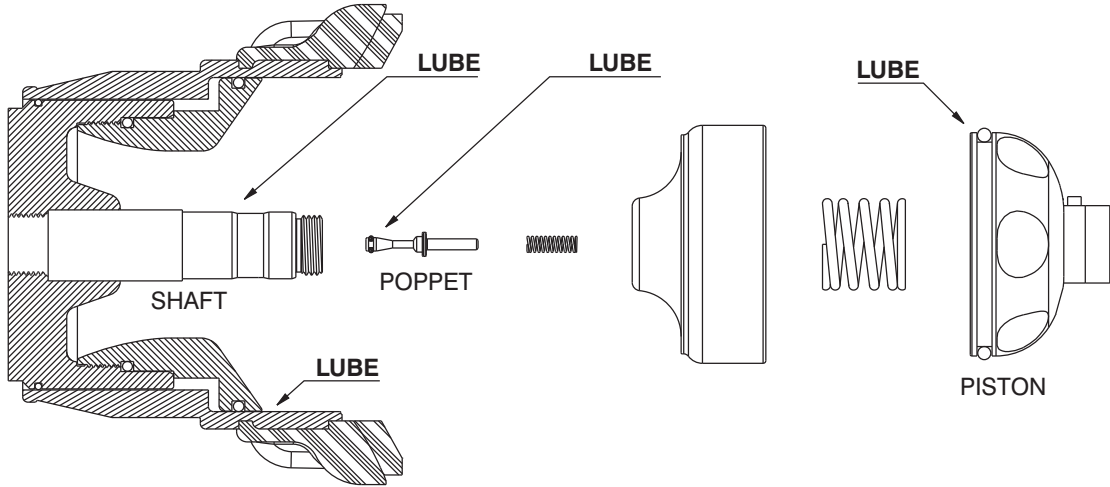

Figure 8.1C

MASTERSTREAM 4000 LUBE POINTS

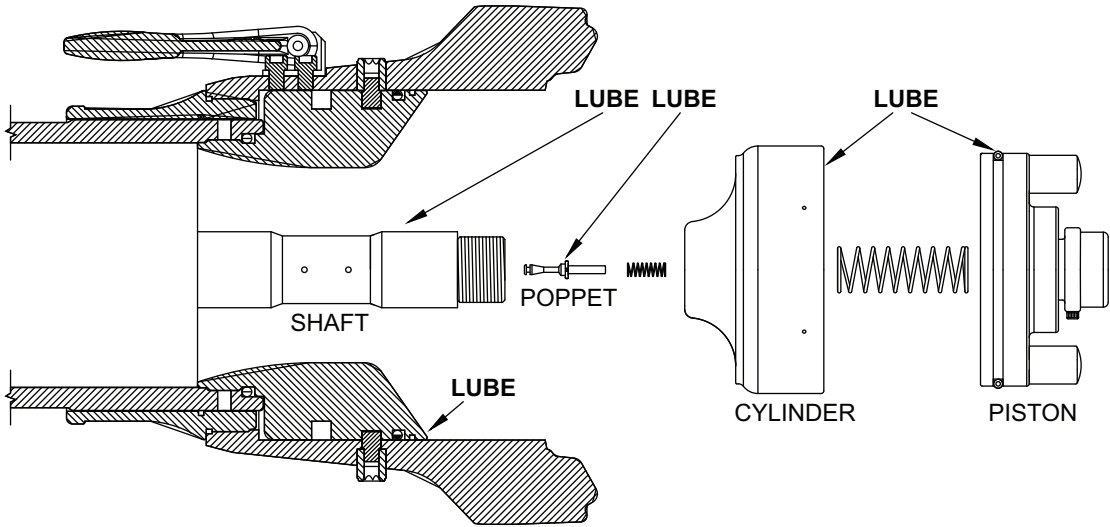

Figure 8.1D

8.2 SERVICE TESTING

In accordance with NFPA 1962, equipment must be tested a minimum of annually. Units failing any part of this test must be removed from service, repaired and retested upon completion of the repair.

8.3 REPAIR

Factory service is available. Factory serviced equipment is repaired by experienced technicians, wet tested to original specifications, and promptly returned. Call TFT service department at 1-800-348-2686 to troubleshoot and, if needed, directions for return. A return for service form can also be obtained at tft.com/Support/Returning-an-Item-for-Service.

Repair parts and service procedures are available for those wishing to perform their own repairs. Task Force Tips assumes no liability for damage to equipment or injury to personnel that is a result of user service. Contact the factory or visit the web site at tft.com for parts lists, exploded views, test procedures and troubleshooting guides.

Performance tests shall be conducted on the equipment after a repair, or anytime a problem is reported to verify operation in accordance with TFT test procedures. Consult factory for the procedure that corresponds to the model and serial number of the equipment. Any equipment which fails the related test criteria should be removed from service immediately. Troubleshooting guides are available with each test procedure or equipment can be returned to the factory for service and testing.



It is the responsibility of service technicians to ensure the use of appropriate protective clothing and equipment. The chosen protective clothing and equipment must provide protection from potential hazards users may encounter while servicing equipment. Requirements for protective clothing and equipment are determined by the Authority Having Jurisdiction (AHJ).



Any alterations to the product or its markings could diminish safety and constitutes a misuse of this product.



All replacement parts must be obtained from the manufacturer to assure proper performance and operation of the device.

9.0 EXPLODED VIEWS AND PARTS LISTS

Exploded views and parts lists are available at tft.com/serial-number.

10.0 OPERATION AND INSPECTION CHECKLIST

BEFORE EACH USE, the nozzle must be inspected to this checklist:

1. There is no obvious damage such as missing, broken or loose parts, damaged labels etc.
2. Waterway is clear of obstructions
3. Coupling is tight and leak free
4. Nozzle flow is adequate as indicated by pump pressure and nozzle reaction
5. Shaper turns freely and adjusts pattern through full range
6. Shaper detent (if so equipped) operates smoothly and positively.

BEFORE BEING PLACED BACK IN SERVICE, nozzles must be inspected to this checklist:

1. All controls and adjustments are operational
2. There are no broken or missing parts
3. There is no damage to the nozzle that could impair safe operation (e.g. dents, cracks, corrosion or other defects)
4. The thread gasket is in good condition
5. The waterway is clear of obstructions
6. Nozzle is clean and markings are legible
7. Coupling is retightened properly
8. Shaper is set to desired pattern



Equipment failing any part of the checklist is unsafe for use and must have the problem corrected before use or being placed back into service. Operating equipment that has failed the checklist is a misuse of this equipment.