



MAX-Series Nozzles

with Automatic Pressure Control
or Fixed Gallonage

INSTRUCTION FOR SAFE OPERATION AND MAINTENANCE

WARNING

Understand manual before use. Operation of this device without understanding the manual and receiving proper training is a misuse of this equipment. Obtain safety information at tft.com/serial-number.

This equipment is intended for use by trained and qualified emergency services personnel for firefighting. All personnel using this equipment shall have completed a course of education approved by the Authority Having Jurisdiction (AHJ).

This instruction manual is intended to familiarize firefighters and maintenance personnel with the operation, servicing, and safety procedures associated with this product. This manual should be kept available to all operating and maintenance personnel.

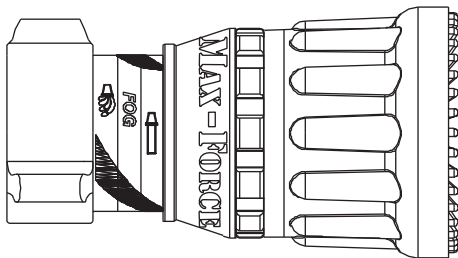

MAX-FORCE™

Dual-Pressure Automatic

Normal Pressure Setting

100 - 500 GPM @ 100 PSI

400 - 2000 l/min @ 7 BAR (700 kPa)

Low Pressure Setting

100 - 500 GPM @ 55 PSI

400 - 2000 l/min @ 4 BAR (400 kPa)

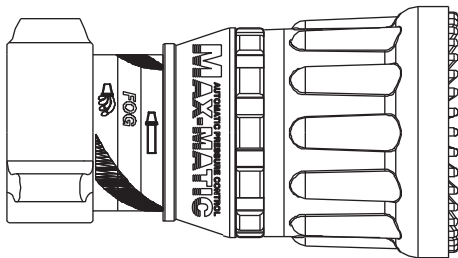

MAX-MATIC™

100 PSI, Single-Pressure Automatic

100 - 500 GPM @ 100 PSI

400 - 2000 l/min @ 7 BAR (700 kPa)

80 PSI, Single-Pressure Automatic

100 - 500 GPM @ 80 PSI

400 - 2000 l/min @ 5.5 BAR (550 kPa)

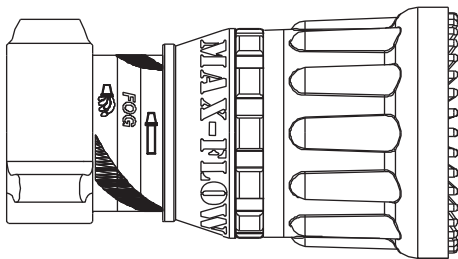

MAX-FLOW™

500 gpm, Fixed Gallonage

500 GPM @ 100 PSI

2000 l/min @ 7 BAR (700 kPa)

All models available in manual and ER versions.

TASK FORCE TIPS LLC

MADE IN USA · tft.com

3701 Innovation Way, Valparaiso, IN 46383-9327 USA

800-348-2686 · 219-462-6161 · Fax 219-464-7155

TABLE OF CONTENTS

- 1.0 MEANING OF SAFETY SIGNAL WORDS
- 2.0 SAFETY
- 3.0 GENERAL INFORMATION
 - 3.1 USE WITH SALT WATER
 - 3.2 VARIOUS MODELS AND TERMS
 - 3.2.1 MECHANICAL SPECIFICATIONS
 - 3.3 ELECTRIC INSTALLATION
 - 3.4 PATTERN CONTROL
 - 3.5 FLUSH CONTROL
 - 3.6 STANDARD/LOW PRESSURE KNOB (MAX-FORCE)
- 4.0 USE OF NOZZLES
- 5.0 FLOW CHARACTERISTICS
 - 5.4 STREAM TRAJECTORY DATA
 - 5.5 FLOW CHARTS
- 6.0 USE WITH FOAM
 - 6.1 FOAM ASPIRATING ATTACHMENTS
- 7.0 WARRANTY
- 8.0 MAINTENANCE
 - 8.1 FIELD LUBRICATION
 - 8.2 SERVICE TESTING
 - 8.3 REPAIR
 - 8.4 EXPLODED VIEW AND PARTS LISTS
- 9.0 OPERATION AND INSPECTION CHECKLIST

DANGER

PERSONAL RESPONSIBILITY CODE

The member companies of FEMSA that provide emergency response equipment and services want responders to know and understand the following:

1. Firefighting and Emergency Response are inherently dangerous activities requiring proper training in their hazards and the use of extreme caution at all times.
2. **IT IS YOUR RESPONSIBILITY** to read and understand any user's instructions, including purpose and limitations, provided with any piece of equipment you may be called on to use.
3. **IT IS YOUR RESPONSIBILITY** to know that you have been properly trained in Firefighting and/or Emergency Response and in the use, precautions, and care of any equipment you may be called upon to use.
4. **IT IS YOUR RESPONSIBILITY** to be in proper physical condition and to maintain the personal skill level required to operate any equipment you may be called upon to use.
5. **IT IS YOUR RESPONSIBILITY** to know that your equipment is in operable condition and has been maintained in accordance with the manufacturer's instructions.
6. Failure to follow these guidelines may result in death, burns or other severe injury.

Fire and Emergency Manufacturers and Service Association, Inc.
PO Box 147, Lynnfield, MA 01940 • www.FEMSA.org

© 2020 FEMSA. All Rights Reserved.

SUPPORTING MATERIALS

The following documents contain supporting safety and operating information pertaining to the equipment described in this manual.

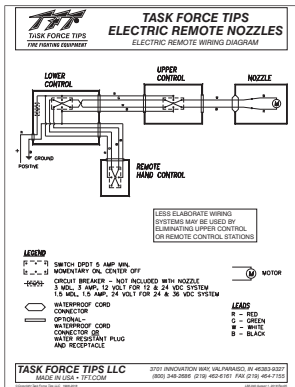

LIM-040 - Electric Remote Nozzle Wiring Diagram

TASK FORCE TIPS
MANUAL: Remote Control (RC) Monitor Electrical Controls

INSTRUCTIONS FOR INSTALLATION, SAFE OPERATION AND MAINTENANCE

⚠ DANGER Intended for use only by trained personnel. Operation of this device without understanding the manual and receiving proper training is a violation of the agreement. Please safety certification is required.

SECTION 4.1 Remote Control Station Assembly	SECTION 4.9 Signal Switch Indicator
SECTION 4.2 Flame Shield	SECTION 4.10 Remote Control Station Assembly
SECTION 4.3 Flame Shield Assembly	SECTION 4.11 Remote Control Station Assembly
SECTION 4.4 Flame Shield Assembly	SECTION 4.12 Remote Control Station Assembly
SECTION 4.5 Flame Shield Assembly	SECTION 4.13 Remote Control Station Assembly
SECTION 4.6 Flame Shield Assembly	SECTION 4.14 Remote Control Station Assembly
SECTION 4.7 Flame Shield Assembly	SECTION 4.15 Remote Control Station Assembly
SECTION 4.8 Flame Shield Assembly	SECTION 4.16 Remote Control Station Assembly
SECTION 4.9 Flame Shield Assembly	SECTION 4.17 Remote Control Station Assembly

TASK FORCE TIPS LLC 3701 INNOVATION WAY, WATERTOWN, MA 02157-0371
MADE IN USA • 977.6554 800.348.4888 • 0176.462.6181 • FAX 0176.464.7158



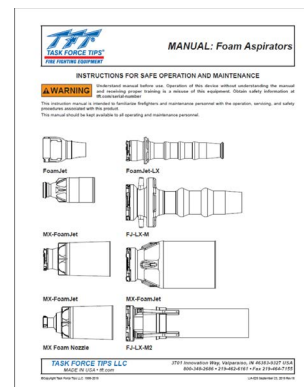

L1Y-500 - Remote Control (RC) Monitor Electrical Controls











LIA-025 - Foam Aspirators Manual

1.0 MEANING OF SAFETY SIGNAL WORDS

A safety related message is identified by a safety alert symbol and a signal word to indicate the level of risk involved with a particular hazard. Per ANSI Z535.6, the definitions of the four signal words are as follows:

	DANGER indicates a hazardous situation which, if not avoided, will result in death or serious injury.
	WARNING indicates a hazardous situation which, if not avoided, could result in death or serious injury.
	CAUTION indicates a potentially hazardous situation which, if not avoided, could result in minor or moderate injury.
	NOTICE is used to address practices not related to physical injury.

2.0 SAFETY

	An inadequate supply of pressure and/or flow will cause an ineffective stream and can result in injury or death. Choose operating conditions to deliver adequate fire suppression. See flow graphs.
	This equipment is intended for use by trained personnel for firefighting. Use of this equipment for other purposes may involve hazards not addressed by this manual. Seek appropriate guidance and training to reduce risk of injury.
	The stream exiting a nozzle is very powerful and capable of causing injury and property damage. Make sure the nozzle is securely attached and pointing in a safe direction before water is turned on. Do not direct water stream to cause injury or damage to persons or property.
	Inadequately supported nozzle reaction force can result in injury or death. The mounting must be capable of supporting the maximum nozzle reaction force as stated in the nozzle's manual.
	Equipment may be damaged if frozen while containing significant amounts of water. Such damage may be difficult to detect visually. Subsequent pressurization can lead to injury or death. Any time the equipment is subject to possible damage due to freezing, it must be tested and approved for use by qualified personnel before being considered safe for use.
	Application of water or foam solutions on energized electrical equipment could cause electrocution. Serious injury or death could result. Assume circuits are energized until confirmed to be de-energized. Do not apply water or foam to energized electrical equipment.
	Mismatched or damaged waterway connections may cause equipment to leak or uncouple under pressure. Failure could result in injury. Equipment must be mated to matched connections.
	Dissimilar metals coupled together can cause galvanic corrosion that can result in the inability to uncouple the connection, or complete loss of engagement over time. Failure could cause injury. Per NFPA 1962, if dissimilar metals are left coupled together, an anti-corrosive lubricant should be applied to the connection and the coupling should be disconnected and inspected at least quarterly.
	To prevent mechanical damage, do not drop or throw equipment.

3.0 GENERAL INFORMATION

The Task Force Tips Max-Force and Max-Matic nozzles are automatic pressure control nozzles. Automatic nozzles operate by sensing the pressure at the nozzle's inlet and adjusting the discharge opening to maintain a constant pressure throughout the flow range of the nozzle. While flowing, the stream pattern can be varied from wide fog to straight stream. Trapped debris can be flushed while flowing.

All Max Series nozzles are constructed of hardcoat anodized aluminum and UV resistant rubber. This rugged construction is compatible with the use of fresh water as well as fire fighting foam solutions.

The Max-Force operates at either standard or low pressure as selected by the nozzle operator. The Max-Matic operates at a single pressure for a given flow range. The Max-Flow is a fixed gallonage nozzle. Available pressures are as follows:

NOZZLE	FLOW RANGE	STANDARD PRESSURE	LOW PRESSURE
MAX-FORCE (Dual Pressure)	100-500 gpm 400-2000 l/min	100 psi 7 bar	55 psi 4 bar
MAX-MATIC, 100 psi (Single Pressure)	100-500 gpm 400-2000 l/min	100 psi 7 bar	
MAX-MATIC, 80 psi (Single Pressure)	100-500 gpm 400-2000 l/min	80 psi 5.5 bar	
MAX-FLOW, 100 psi (Fixed Gallonage)	500 gpm 2000 l/min	100 psi 7 bar	

Table 3.0

3.1 USE WITH SALT WATER

Use with salt water is permissible provided the equipment is thoroughly cleaned with fresh water after each use. The service life of the equipment may be shortened due to the effects of corrosion, and is not covered under warranty.

3.2 VARIOUS MODELS AND TERMS

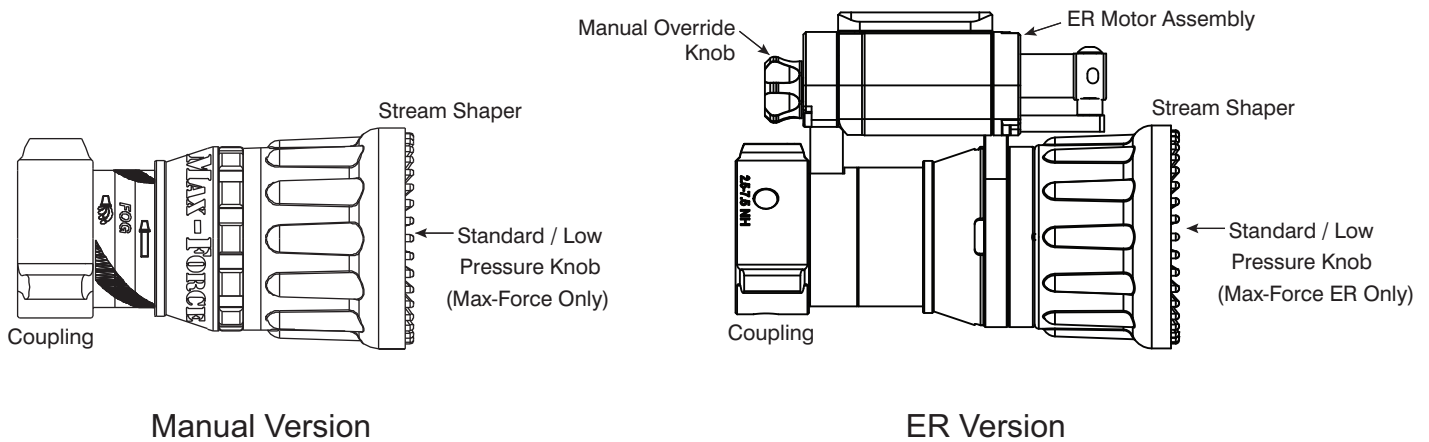

Figure 3.2

3.2.1 MECHANICAL SPECIFICATIONS

Weight (Max-Force)	6.7 lb (3.0 kg)
(Max-Matic & Max-Flow)	6.5 lb (2.9 kg)
(Max-Force ER)	10.2 lb (4.6 kg)
(Max-Matic ER & Max-Flow ER)	10.0 lb (4.5 kg)
Maximum Operating Pressure	Varies by Model (see Table 3 on page 4)
Maximum Fog Angle	100°
Operating temperature range of fluid	33 to 120°F (1 to 50°C)
Storage temperature range	-40 to 150°F (-40 to 65°C)
Materials used	Aluminum 6000 series hard anodized MIL8625 class 3 type 2, stainless steel 300 series, nylon 6-6, nitrile rubber

Table 3.2.1

3.3 ELECTRIC INSTALLATION

Nozzles with electric stream shaper actuation are shipped with wiring diagram LIM-040. For nozzle installation, refer to LIY-500 Remote Control (RC) Monitor Electrical Controls (shipped with TFT Monitors or available at tft.com). Max-series ER nozzles are equipped with manual override in case of electrical power failure.



This device is not rated as ignition proof, explosion proof, or intrinsically safe. Use only in locations with adequate ventilation and no hazard of flammable vapor buildup.

3.4 PATTERN CONTROL

TFT nozzles have full pattern control from straight stream to wide fog. Turning the stream shaper clockwise (as seen from the operating position behind the nozzle) moves the shaper to the straight stream position. Turning the shaper counterclockwise will result in an increasingly wider pattern.

Since the stream trim point varies with flow, the stream should be “trimmed” after changing the flow to obtain the straightest and farthest reaching stream. To properly trim the stream, first open the pattern to narrow fog. Then close the stream to parallel to give maximum reach. Turning the shaper further forward will cause stream crossover and reduce the effective reach of the nozzle.



The nozzle reaction is greatest when the shaper is in the straight stream position. Sudden changes in pattern can cause changes in reaction, leading to loss of footing or an out of control nozzle. The nozzle operator must be prepared for a change in reaction as the pattern is changed.



Dents or nicks in the nozzle tip can seriously affect the stream reach or pattern, which may increase the risk of injury due to exposure. Care must be taken to avoid dents or nicks in the nozzle tip.



Turning the shaper further forward will cause stream crossover and reduce the reach of the nozzle.

3.5 FLUSH CONTROL

Small debris passes through the debris screen (if so equipped) and may get caught inside the nozzle. This trapped material will cause poor stream quality, shortened reach, and reduced flow. To remove small debris, the nozzle may be flushed as follows:

- While still flowing water, rotate the shaper counterclockwise (as viewed from behind the nozzle) to the flush position. (increased resistance will be felt on the SHAPER as the nozzle goes into flush) This will open the nozzle allowing debris to pass through.
- During flush the nozzle reaction will decrease as the pattern becomes wider and the pressure drops. The nozzle operator must be prepared for an increase of nozzle reaction when returning the nozzle from the flush position to retain control of the nozzle.
- Rotate the shaper out of flush to continue normal operations.



Large amounts or pieces of debris may be unflushable and can reduce the flow of the nozzle resulting in an ineffective flow. In the event of a blockage, it may be necessary to retreat to a safe area, uncouple the nozzle and remove debris.

3.6 STANDARD/LOW PRESSURE KNOB (MAX-FORCE)

For situations where 100 psi at the nozzle is impractical, the Max-Force dual pressure knob may be switched to low pressure mode. In the low pressure mode, the nozzle pressure is reduced by about 50%, while maintaining a usable stream and increasing the flow. The nozzle operator must be prepared for a change in reaction when changing modes.

To switch to the low pressure mode, shut off water flow to nozzle and turn knob at front of nozzle counterclockwise (when viewed from front). Nozzle will now operate at reduced pressure. Repeat the process, except turn knob clockwise, to return to 100 psi operation.

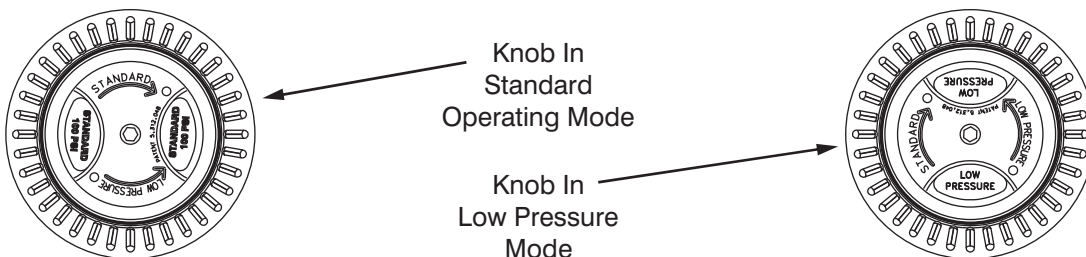

Figure 3.6

4.0 USE OF NOZZLES

IT IS THE RESPONSIBILITY OF THE INDIVIDUAL FIRE DEPARTMENT OR AGENCY TO DETERMINE PHYSICAL CAPABILITIES AND SUITABILITY FOR AN INDIVIDUAL'S USE OF THIS EQUIPMENT.

Many factors contribute to the extinguishment of a fire. Among the most important is delivering water at a flow rate sufficient to absorb heat faster than it is being generated. The flow rate depends largely on the pump discharge pressure and hose friction loss. It can be calculated using a hydraulic equation such as:

$$PDP = NP + FL + DL + EL$$

PDP = Pump Discharge Pressure in psi

NP = Nozzle Pressure in psi

FL = Hose Friction Loss in psi

DL = Device Loss in psi

EL = Elevation Loss in psi

This Safety Manual is not intended as a substitute for proper training in the use of rescue systems as taught from credible sources such as the National Fire Protection Association (NFPA), the International Fire Service Training Association (IFSTA), or sources approved by the Authority Having Jurisdiction (AHJ).

5.0 FLOW CHARACTERISTICS

The following graphs show typical performance of the various models of Max Series nozzles.

100 PSI MAX-MATIC & MAX-FORCE

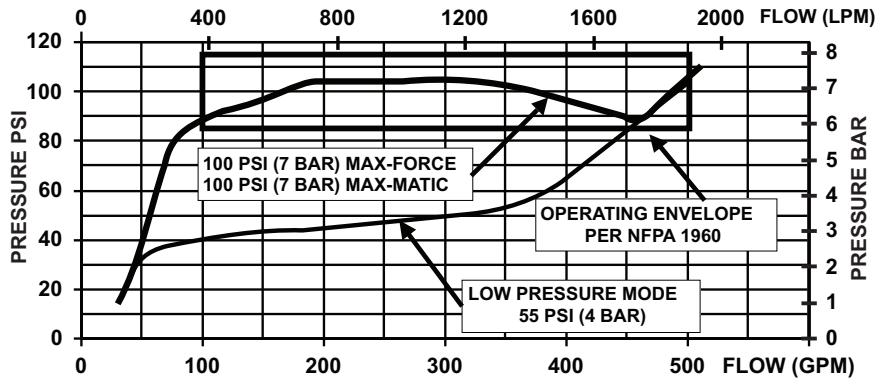

Figure 5.0A

80 PSI MAX-MATIC

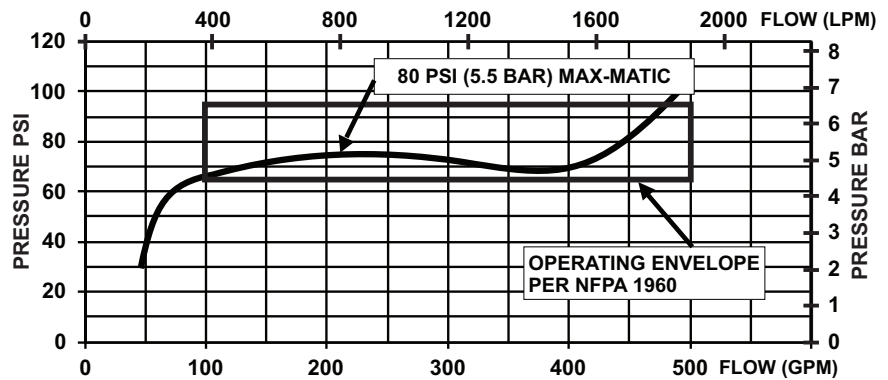

Figure 5.0B

100 PSI MAX-FLOW

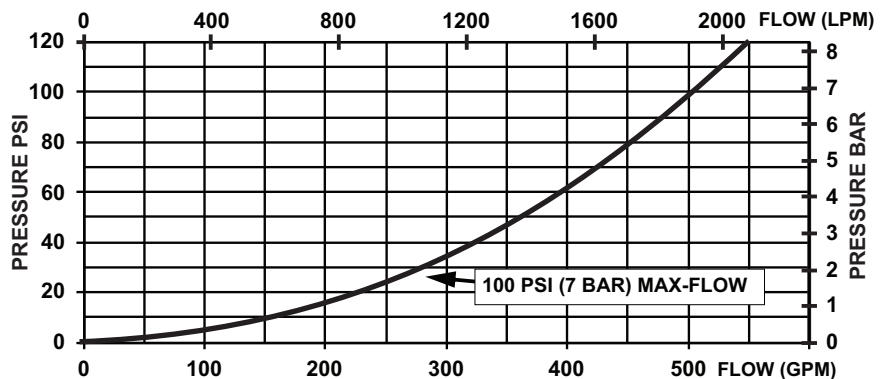

Figure 5.0C

5.4 STREAM TRAJECTORY DATA

The tables and graphs in this section give the stream trajectory for the Max-Series nozzles at various flows.

Notes on trajectory graphs:

- Graphs show approximate effective stream trajectory at 30 degrees elevation in no wind conditions. Distance to last water drops approximately 10% farther.
- To estimate trajectories at elevations other than 30 degrees, refer to document LTT-135, available at tft.com.
- Trajectories shown are for water. The addition of foam is expected to decrease the reach by 10%.
- Tail or head winds of 20 MPH (30 KPH) may increase or decrease the range approximately 30%.
- Stream trajectory based on "The Trajectories of Large Fire Fighting Jets" by A.P. Hatton and M.J. Osborne, Reference: "The International Journal of Heat and Fluid Flow", Vol 1 No 1.
- Curves C, D, and E represent trajectory data for the 2000, 3000, and 4000 settings of the 100 psi selectable nozzle.

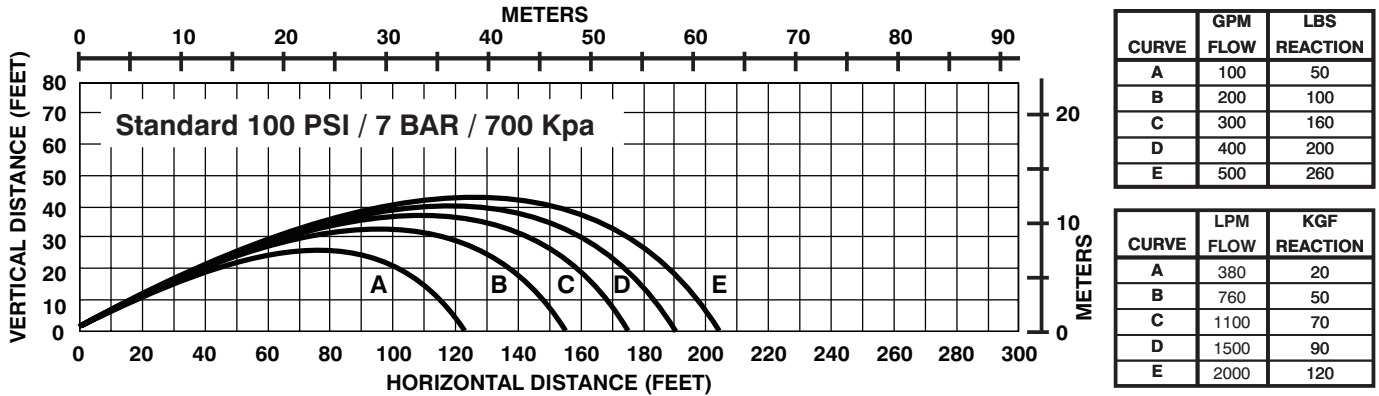

Figure 5.4A

Standard 100 psi / 7 bar / 700 kPa

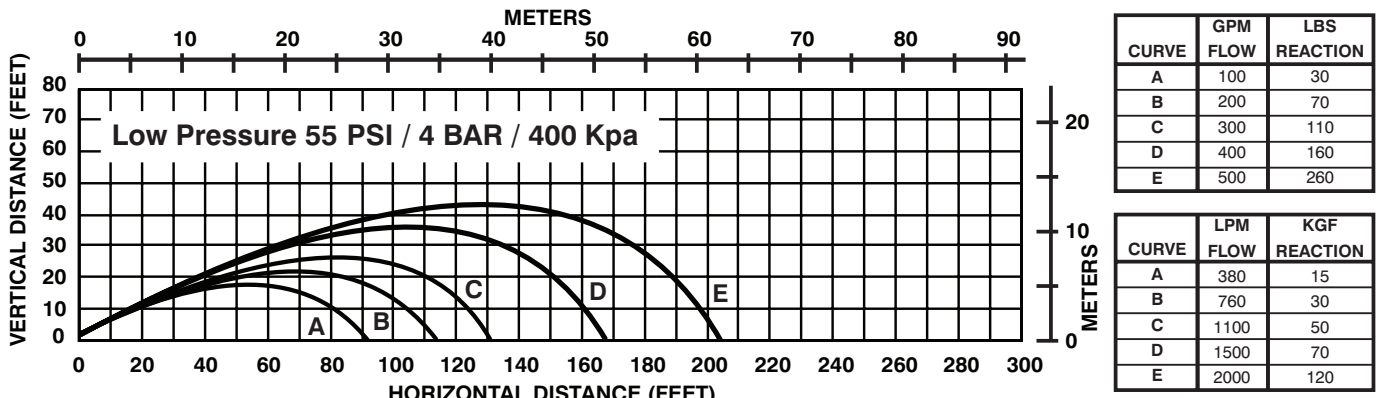

Figure 5.4B

Low Pressure 55 psi / 4 bar / 400 kPa

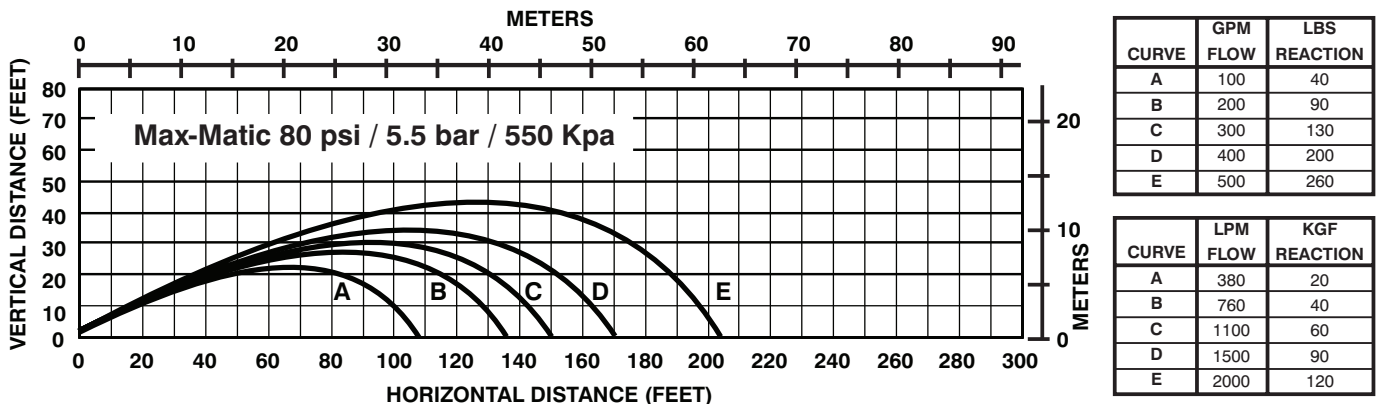

Figure 5.4C

Max-Matic 80 psi / 5.5 bar / 550 kPa

5.5 FLOW CHARTS

**MAX-FORCE
MAX-MATIC 100 PSI
ON BLITZFIRE**

PUMP PRESSURE (PSI)	2-1/2" HOSE				3" HOSE			
	100 FT	150 FT	200 FT	300 FT	100 FT	150 FT	200 FT	300 FT
100	140	130	120	110	150	140	140	130
125	270	230	210	180	460	310	280	250
150	460	350	300	260	500	490	470	400
175	500	460	400	320	---	---	---	480
200	---	500	470	380	---	---	---	---

FLOWS IN GPM

Figure 5.5A

**MAX-FORCE
LOW PRESSURE
SETTING
ON BLITZFIRE**

PUMP PRESSURE (PSI)	2-1/2" HOSE				3" HOSE			
	100 FT	150 FT	200 FT	300 FT	100 FT	150 FT	200 FT	300 FT
100	380	350	320	270	410	400	390	370
125	420	400	370	330	460	450	430	410
150	460	430	410	370	500	490	470	450
175	500	470	440	400	---	---	---	480
200	---	500	470	430	---	---	---	---

FLOWS IN GPM

Figure 5.5B

**MAX-MATIC 80 PSI
ON BLITZFIRE**

PUMP PRESSURE (PSI)	2-1/2" HOSE				3" HOSE			
	100 FT	150 FT	200 FT	300 FT	100 FT	150 FT	200 FT	300 FT
100	310	250	230	190	410	390	350	280
125	420	380	330	270	470	450	440	410
150	460	430	410	340	500	490	480	450
175	500	470	440	390	---	---	---	480
200	---	500	470	430	---	---	---	---

FLOWS IN GPM

Figure 5.5C

**MAX-FLOW 100 PSI
ON BLITZFIRE**

PUMP PRESSURE (PSI)	2-1/2" HOSE				3" HOSE			
	100 FT	150 FT	200 FT	300 FT	100 FT	150 FT	200 FT	300 FT
100	380	360	34	300	420	400	390	370
125	430	400	380	340	470	450	450	410
150	470	440	410	370	---	500	500	450
175	500	470	440	400	---	---	---	490
200	---	500	480	430	---	---	---	---

FLOWS IN GPM

Figure 5.5D

NOTES:

1. Number in each box indicates flow in gpm.
2. Flows may vary with brand and condition of hose.
3. Flows are approximate and include device loss.
4. Flows are approximate and do not reflect losses in pump piping or elevation changes.
5. Nozzle reaction can be as high as 250 lbs. (500 gpm + 100 psi)

6.0 USE WITH FOAM

The nozzle may be used with foam solutions. Refer to fire service training by the Authority Having Jurisdiction (AHJ) for the proper use of foam.



For Class B fires, lack of foam or interruption in the foam stream can cause a break in the foam blanket and greatly increase the risk of injury or death. Follow procedures established by the AHJ for the specific fuel and conditions.



Improper use of foam or using the wrong type of foam can result in illness, injury, or damage to the environment. Follow foam manufacturer's instructions and fire service training as directed by the AHJ.

6.1 FOAM ASPIRATING ATTACHMENTS

Multi-expansion or low expansion aspirating attachments may be used with nozzles to increase the expansion ratio. These foam tubes attach and detach quickly from the nozzle. As expansion ratio is increased, the reach of the nozzle will decrease due to the greater amount of bubbles in the stream and their ability to penetrate the air. Generally, the straight stream reach with foam is approximately 10% less than with water only. Actual results will vary based on brand of foam, hardness of water, temperature, etc. For specific information, see LIA-025 (MANUAL: Foam Attachments for TFT Nozzles).

7.0 WARRANTY

Task Force Tips LLC, 3701 Innovation Way, Valparaiso, Indiana 46383-9327 USA ("TFT") warrants to the original purchaser of its products ("equipment"), and to anyone to whom it is transferred, that the equipment shall be free from defects in material and workmanship during the five (5) year period from the date of purchase for mechanical components, and the two (2) year period from the date of purchase for electrical components. TFT's obligation under this warranty is specifically limited to replacing or repairing the equipment (or its parts) which are shown by TFT's examination to be in a defective condition attributable to TFT. To qualify for this limited warranty, the claimant must return the equipment to TFT, at 3701 Innovation Way, Valparaiso, Indiana 46383-9327 USA, within a reasonable time after discovery of the defect. TFT will examine the equipment. If TFT determines that there is a defect attributable to it, TFT will correct the problem within a reasonable time. If the equipment is covered by this limited warranty, TFT will assume the expenses of repair.

If any defect attributable to TFT under this limited warranty cannot be reasonably cured by repair or replacement, TFT may elect to refund the purchase price of the equipment, less reasonable depreciation, in complete discharge of its obligations under this limited warranty. If TFT makes this election, claimant shall return the equipment to TFT free and clear of any liens and encumbrances.

This is a limited warranty. The original purchaser of the equipment, any person to whom it is transferred, and any person who is an intended or unintended beneficiary of the equipment, shall not be entitled to recover from TFT any consequential or incidental damages for injury to person and/or property resulting from any defective equipment manufactured or assembled by TFT.

It is agreed and understood that the price stated for the equipment is in part consideration for limiting TFT's liability. Some states do not allow the exclusion or limitation of incidental or consequential damages, so the above may not apply to you.

TFT shall have no obligation under this limited warranty if the equipment is, or has been, misused or neglected (including failure to provide reasonable maintenance) or if there have been accidents to the equipment or if it has been repaired or altered by someone else.

THIS IS A LIMITED EXPRESS WARRANTY ONLY. TFT EXPRESSLY DISCLAIMS WITH RESPECT TO THE EQUIPMENT ALL IMPLIED WARRANTIES OF MERCHANTABILITY AND ALL IMPLIED WARRANTIES OF FITNESS FOR A PARTICULAR PURPOSE. THERE IS NO WARRANTY OF ANY NATURE MADE BY TFT BEYOND THAT STATED IN THIS DOCUMENT.

This limited warranty gives you specific legal rights, and you may also have other rights which vary from state to state.

8.0 MAINTENANCE

TFT nozzles are designed and manufactured to be damage resistant and require minimal maintenance. However, as the primary firefighting tool upon which your life depends, it should be treated accordingly. Do not drop or throw equipment.

When reassembling the automatic nozzles after repairs or for preventive maintenance, coat the seal on the piston, the inner bore of the cylinder and the shaft slide surface with a waterproof lubricant such as Molykote #112 Silicone Grease. Lubrication is required to assure continued smooth operation. The frequency of lubrication will depend on frequency of usage and storage conditions. Nozzles must be checked regularly to assure proper operation.

Contact factory for parts lists and exploded views for particular models. Each nozzle is identified by a serial number located on the nozzle's stream shaper.

8.1 FIELD LUBRICATION

All Task Force Tips nozzles are factory lubricated with high quality silicone grease. This lubricant has excellent wash out resistance, providing long term performance. If your agency has unusually hard or sandy water, the moving parts of the nozzle may be affected. Foam agents and water additives contain soaps and chemicals that may break down the factory lubrication.

The moving parts of the nozzle should be checked on a regular basis for smooth and free operation, and for signs of damage. IF THE NOZZLE IS OPERATING CORRECTLY, THEN NO ADDITIONAL LUBRICANT IS NEEDED. Any nozzle that is not operating correctly should be immediately removed from service. The nozzle can be returned to the factory at any time for a complete checkup and re-lubrication with silicone grease.

The field use of Break Free CLP (spray or liquid) lubricant will help to temporarily restore the smooth and free operation of the nozzle. These lubricants do not have the washout resistance and long-term performance of the silicone grease. Once Break Free CLP is applied, re-application will be needed on a regular basis until the nozzle can be returned to the factory for a complete checkup and re-lubrication with silicone grease.



Aerosol lubricants contain solvents that can swell O-Rings if applied in excess. The swelling can inhibit smooth operation of the moving parts. When used in moderation, as directed, the solvents quickly evaporate without adversely swelling the O-Rings.

8.2 SERVICE TESTING

In accordance with NFPA 1962, equipment must be tested a minimum of annually. Units failing any part of this test must be removed from service, repaired and retested upon completion of the repair.

8.3 REPAIR

Factory service is available. Factory serviced equipment is repaired by experienced technicians, wet tested to original specifications, and promptly returned. Call TFT service department at 1-800-348-2686 to troubleshoot and, if needed, directions for return. A return for service form can also be obtained at tft.com/Support/Returning-an-Item-for-Service.

Repair parts and service procedures are available for those wishing to perform their own repairs. Task Force Tips assumes no liability for damage to equipment or injury to personnel that is a result of user service. Contact the factory or visit the web site at tft.com for parts lists, exploded views, test procedures and troubleshooting guides.

Performance tests shall be conducted on the equipment after a repair, or anytime a problem is reported to verify operation in accordance with TFT test procedures. Consult factory for the procedure that corresponds to the model and serial number of the equipment. Any equipment which fails the related test criteria should be removed from service immediately. Troubleshooting guides are available with each test procedure or equipment can be returned to the factory for service and testing.



It is the responsibility of service technicians to ensure the use of appropriate protective clothing and equipment. The chosen protective clothing and equipment must provide protection from potential hazards users may encounter while servicing equipment. Requirements for protective clothing and equipment are determined by the Authority Having Jurisdiction (AHJ).



Any alterations to the product or its markings could diminish safety and constitutes a misuse of this product.



All replacement parts must be obtained from the manufacturer to assure proper performance and operation of the device.

8.4 EXPLODED VIEW AND PARTS LISTS

Exploded views and parts lists are available at tft.com/serial-number.

9.0 OPERATION AND INSPECTION CHECKLIST

BEFORE EACH USE, the nozzle must be inspected to this checklist:

1. There is no obvious damage such as missing, broken or loose parts, damaged labels etc.
2. Waterway is clear of obstructions
3. Coupling is tight and leak free
4. Valve operates freely through full range and regulates flow
5. "OFF" position shuts off fully and flow is stopped
6. Nozzle flow is adequate as indicated by pump pressure and nozzle reaction
7. Shaper turns freely and adjusts pattern through full range
8. Nozzle smoothly moves into full flush and out of flush with normal flow and pressure restored
9. Shaper detent (if so equipped) operates smoothly and positively.

BEFORE BEING PLACED BACK IN SERVICE, nozzles must be inspected to this checklist:

1. All controls and adjustments are operational
2. Shut off valve (if so equipped) closes off the flow completely
3. There are no broken or missing parts
4. There is no damage to the nozzle that could impair safe operation (e.g. dents, cracks, corrosion or other defects)
5. The thread gasket is in good condition
6. The waterway is clear of obstructions
7. Nozzle is clean and markings are legible
8. Coupling is tightened properly
9. Shaper is set to desired pattern
10. Shutoff handle (if so equipped) is stored in the OFF position



Equipment failing any part of the checklist is unsafe for use and must have the problem corrected before use or being placed back into service. Operating equipment that has failed the checklist is a misuse of this equipment.